

TURBO MACHINES**Subject Code: 15ME53****Hours/Week: 05****Total Hours: 50****IA Marks: 20****Exam Hours: 03****Exam Marks: 80****Module - I**

Introduction: Definition of turbo machine, parts of turbo machines, Comparison with positive displacement machines, Classification, Dimensionless parameters and their significance, Effect of Reynolds number, Unit and specific quantities, model studies. (Note: Since dimensional analysis is covered in Fluid Mechanics subject, questions on dimensional analysis may not be given. However, dimensional parameters and model studies may be given more weightage.)

Thermodynamics of fluid flow: Application of first and second law of thermodynamics to turbo machines, Efficiencies of turbo machines, Static and Stagnation states, Incompressible fluids and perfect gases, overall isentropic efficiency, stage efficiency (their comparison) and polytropic efficiency for both compression and expansion processes. Reheat factor for expansion process. **10 Hours**

expansion process

Module –II

Energy exchange in Turbo machines: Euler's turbine equation, Alternate form of Euler's turbine equation, Velocity triangles for different values of degree of reaction, Components of energy transfer, Degree of Reaction, utilization factor, Relation between degree of reaction and Utilization factor, Problems.

General Analysis of Turbo machines: Radial flow compressors and pumps – general analysis, Expression for degree of reaction, velocity triangles, Effect of blade discharge angle on energy transfer and degree of reaction, Effect of blade discharge angle on performance, Theoretical head – capacity relationship, General analysis of axial flow pumps and compressors, degree of reaction, velocity triangles, Problems. **10 Hours**

Module –III

Steam Turbines: Classification, Single stage impulse turbine, condition for maximum blade efficiency, stage efficiency, Need and methods of compounding, Multi-stage impulse turbine, expression for maximum utilization factor.

Reaction turbine – Parsons's turbine, condition for maximum utilization factor, reaction staging. Problems. **10 Hours**

Module –IV

Hydraulic Turbines: Classification, various efficiencies. Pelton turbine – velocity triangles, design parameters, Maximum efficiency. **Francis turbine** - velocity triangles, design parameters, runner shapes for different blade speeds. Draft tubes- Types and functions. **Kaplan and Propeller turbines** – velocity triangles, design parameters. Problems. **10 Hours**

Module –V

Centrifugal Pumps: Classification and parts of centrifugal pump, different heads and efficiencies of centrifugal pump, Minimum speed for starting the flow, Maximum suction lift, Net positive suction head, Cavitation, Need for priming, Pumps in series and parallel. Problems.

Centrifugal Compressors: Stage velocity triangles, slip factor, power input factor, Stage work, Pressure developed, stage efficiency and surging and problems. Axial flow Compressors: Expression for pressure ratio developed in a stage, work done factor, efficiencies and stalling. Problems. **10 Hours**

TEXT BOOKS:

1. An Introduction to Energy Conversion, Volume III, Turbo machinery, V. Kadambi and Manohar Prasad, New Age International Publishers, reprint 2008.
2. Turbines, Compressors & Fans, S. M. Yahya, Tata McGraw Hill Co. Ltd., 2nd edition, 2002
3. Turbomachines, B. U Pai , Wiley First Edition 2013.

REFERENCE BOOKS:

1. Principals of Turbo machines, D. G. Shepherd, The Macmillan Company (1964).
2. Fluid Mechanics & Thermodynamics of Turbo machines, S. L. Dixon, Elsevier (2005).
3. Turbo machine, B.K.Venkanna PHI, New Delhi 2009.
4. Text Book of Turbo machines, M. S. Govindgouda and A. M. Nagaraj, M. M. Publications, 4Th Ed, 2008.

MODULE: 1

INTRODUCTION

Definition of a Turbo machine

A turbo machine is a device in which energy transfer occurs between a flowing fluid and rotating element due to dynamic action. This results in change of pressure and momentum of the fluid.

Parts of a turbo machine

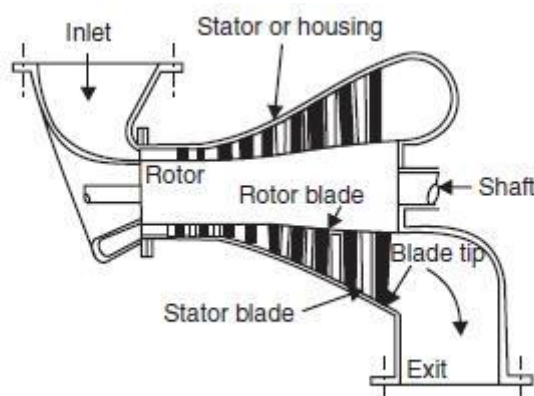

Fig: 1.1. Schematic cross-sectional view of a turbine showing the principal parts of the turbomachine.

The principle components of a turbo machine are:

1. **Rotating element** (vane, impeller or blades)– operating in a stream of fluid.
2. **Stationary elements** – which usually guide the fluid in proper direction for efficient energy conversion process.
3. **Shaft** – This either gives input power or takes output power from fluid under dynamic conditions and runs at required speed.
4. **Housing** – to keep various rotating, stationery and other passages safely under dynamic conditions of the flowing fluid.

E.g. Steam turbine parts and Pelton turbine parts.

Classification of turbo machines

1. Based on energy transfer

- a) Energy is given by fluid to the rotor - Power generating turbo machine E.g. Turbines
- b) Energy given by the rotor to the fluid – Power absorbing turbo machine E.g. Pumps, blowers and compressors

2. Based on fluid flowing in turbo machine

- a) Water
- b) Air
- c) Steam
- d) Hot gases
- e) Liquids like petrol etc.

3. Based on direction of flow through the impeller or vanes or blades, with reference to the axis of shaft rotation

- a) Axial flow – Axial pump, compressor or turbine
- b) Mixed flow – Mixed flow pump, Francis turbine
- c) Radial flow – Centrifugal pump or compressor
- d) Tangential flow – Pelton water turbine

4. Based on condition of fluid in turbo machine

- a) Impulse type (constant pressure) E.g. Pelton water turbine
- b) Reaction type (variable pressure) E.g. Francis reaction turbines

5. Based on position of rotating shaft a)
Horizontal shaft – Steam turbines

- b) Vertical shaft – Kaplan water turbines c)
- Inclined shaft – Modern bulb micro

Comparison between positive displacement machines and Turbo machines

Comparison between positive displacement machines and Turbo machines	
Turbo machines	Positive displacement machines
<input type="checkbox"/> It creates Thermodynamic & Dynamic action b/w rotating element & flowing fluid, energy transfer takes place if pressure and momentum changes	It creates Thermodynamic & Mechanical action b/w moving member & static fluid, energy transfer takes place with displacement of fluid
<input type="checkbox"/> It involves a steady flow of fluid & rotating motion of mechanical element	It involves a unsteady flow of fluid & reciprocating motion
<input type="checkbox"/> They operate at high rotational speed	They operate at low speed
<input type="checkbox"/> Change of phase during fluid flow causes serious problems in turbomachine	Change of phase during fluid flow causes less problems in Positive displacement machines
<input type="checkbox"/> Efficiency is usually less	Efficiency is higher
<input type="checkbox"/> It is simple in design	It is complex in design
<input type="checkbox"/> Due to rotary motion vibration problems are less	Due to reciprocating motion vibration problems are more
E.g. Hydraulic turbines, Gas turbines, Steam turbines etc.	E.g. I.C engines, Reciprocating air compressor, pumps etc.

Effect of Reynolds Number

Just like flow in pipes with friction, with decreasing Reynolds number, the loss factor increases at first slowly, then more and more rapidly in Turbo machines.

The majority of ordinary turbo machines, (handling water, air, steam or gas) are found to operate in fully rough region.

The critical Reynolds number, at which the flow becomes fully rough, varies with the size of the machine (it depends on relative roughness) and its exact location for a given machine is difficult to predict.

The understanding of boundary layer and its separation is of importance in losses. The graph shows the loss factor in head and efficiency of a moderate size centrifugal pump

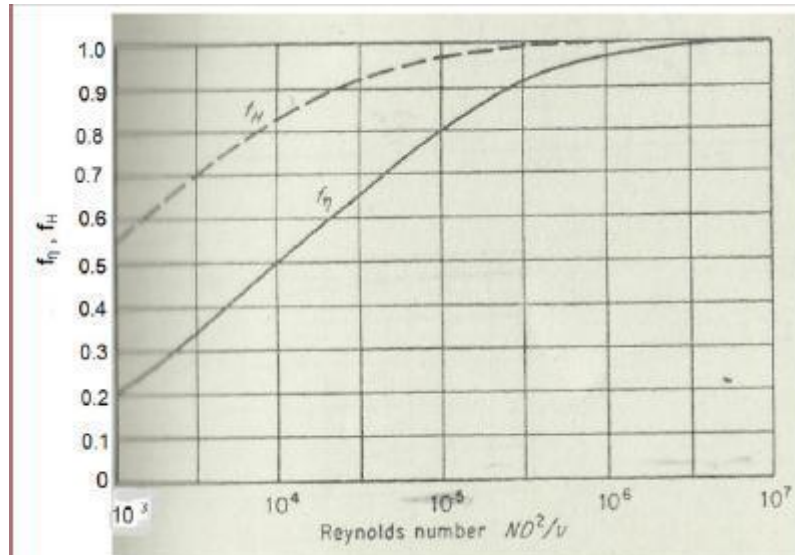

Unit Quantities

Unit quantities are unit flow, unit power and unit speed which are under considerations of unit meter in connection with hydraulic turbines. In other words, the unit quantities are defined for the head of 1m.

(a) Unit flow: Unit flow is the flow of $1\text{m}^3/\text{s}$ that occurs through the turbomachine while working under a head of 1m. Q_U

W.k.t the discharge through a turbine is given by

$$Q = \text{Area} \times \text{Velocity}$$

Since the area of flow for a turbine is constant

$$Q \propto V$$

$$V = C_v \sqrt{2gH}$$

$$V \propto \sqrt{H}$$

$$Q \propto \sqrt{H}$$

$$Q = K\sqrt{H}$$

When $H=1\text{m}$, $Q=Q_u$, substituting these conditions in the above equation

$$Q_U = K\sqrt{1}$$

$$\text{Then } Q = Q_U\sqrt{H}$$

$$Q_U = \frac{Q}{\sqrt{H}}$$

(b) **Unit Speed:** Speed of the turbine working under a unit head. N_U

W.k.t the peripheral velocity of the vanes is given by,

$$U = \sqrt{2gH}$$

$$U \propto \sqrt{H}$$

Also

$$U = \frac{\pi DN}{60}$$

$$U \propto \sqrt{H}$$

Comparing above two equations

$$N \propto \sqrt{H}$$

$$N = K\sqrt{H}$$

When $H=1\text{m}$, $U=U_u$, substituting these conditions in the above equation

$$N_U = K\sqrt{1}$$

$$K = N_U$$

Then

$$N_U = \frac{N}{\sqrt{H}}$$

(c) **Unit Power:** The power developed by the turbine working under a unit head. P_U

W.k.t the overall efficiency of the turbine is given by,

$$\eta_o = \frac{P}{\frac{WQH}{1000}}$$

$$P = \eta_o \frac{WQH}{1000}$$

$$P \propto QH$$

$$P \propto \sqrt{H} \times H$$

$$P \propto H^{3/2}$$

$$P = KH^{3/2}$$

When $H=1\text{m}$, $P=P_U$, substituting these condition in above equation

$$P_U = K \times 1^{3/2}$$
$$K = P_U$$
$$P = P_U \times H^{3/2}$$

Then

$$P_U = \frac{P}{H^{3/2}}$$

Dimensionless groups and their significance

The Performance of a turbomachine like pumps, water turbines, fans or blowers for incompressible flow can be expressed as a function of:

- (i) Density of the fluid
- (ii) Speed of the rotor N
- (iii) Characteristic diameter D
- (iv) Discharge Q
- (v) Gravity head (gH)
- (vi) Power developed P and
- (vii) Viscosity μ .

Obtain dimensionless groups and explain their significance.

Solution

Using Buckingham p theorem

Turbo machine = $f [\rho, N, D, Q, gH, P, \mu]$
Performance

Taking N, D as repeating variables and grouping with other variables as non dimensional groups

$$\pi_1 = [\rho^{a1}, N^{b1}, D^{c1}, Q]$$

$$\pi_2 = [\rho^{a2}, N^{b2}, D^{c2}, H]$$

$$\pi_3 = [\rho^{a3}, N^{b3}, D^{c3}, H]$$

$$\pi_4 = [\rho^{a4}, N^{b4}, D^{c4}, \mu]$$

$$\pi_1 = \frac{Q}{ND^3} \text{ Flow coefficient}$$

$$\pi_2 = \frac{H}{N^2 D^2} \text{ Head coefficient}$$

$$\pi_3 = \frac{P}{\rho N^3 D^5} \text{ Power coefficient}$$

$$\pi_4 = \frac{\mu}{\rho N D^2} \text{ Reynolds number}$$

For model studies for similar turbomachines, we can use

For model studies for similar turbomachines, we can use

$$\frac{Q_1}{N_1 D_1^3} = \frac{Q_2}{N_2 D_2^3}$$

$$\frac{H_1}{N_1^2 D_1^2} = \frac{H_2}{N_2^2 D_2^2}$$

$$\frac{P_1}{\rho_1 N_1^3 D_1^5} = \frac{P_2}{\rho_2 N_2^3 D_2^5}$$

$$\frac{\mu_1}{\rho_1 N_1 D_1^2} = \frac{\mu_2}{\rho_2 N_2 D_2^2}$$

Significance of Non Dimensional π Groups

1. Discharge coefficient or capacity coefficient

$\pi_1 = \frac{Q}{ND^3} = C_1$ is capacity coefficient or flow coefficient for similar Turbo machines.

$$\pi_1 = \frac{Q}{ND^3} \propto \frac{D^2 V}{ND^3} \propto \frac{V}{ND} \quad \text{As } Q = AV = \frac{\pi D^2}{4} V$$

$$\pi_1 = \frac{V}{U} = \frac{1}{\phi}$$

Where ϕ is called speed ratio = $\frac{U}{V}$

For any given turbo machine, speed ratio is fixed.

For a given pump or fan of certain diameter running at various speeds the discharge is proportional to speed.

2. Head coefficient

$\pi_2 = \frac{H}{N^2 D^2}$ Is called head coefficient.

$$\pi_2 = \frac{H}{N^2 D^2} = \frac{H}{U^2} \quad \text{i. e } U \propto ND$$

The above ratio shows that head coefficient will be similar for same type of pumps or turbines for given impeller size and head varies as square of the tangential speed of the rotor.

3. Power coefficient

$\pi_3 = \frac{P}{\rho N^3 D^5}$ is called power coefficient or Specific power.

For a given pump or a water turbine, the power is directly proportional to the cube of the speed of runner.

SPECIFIC SPEED – Pumps, fans, blowers and compressors

Specific Speed (Ω) is a dimensionless term of great importance in pumps, fans, blowers and compressors

$$\text{Where } \pi_5 = \frac{(\pi_1)^{1/2}}{(\pi_2)^{3/4}} = \frac{Q^{1/2}}{(ND^3)^{1/2}} \times \frac{(D^2 N^2)^{3/4}}{(gH)^{3/4}} = \frac{NQ^{1/2}}{(gH)^{3/4}}$$

This can also be expressed as,

$$N_s = \frac{N\sqrt{Q}}{H^{3/4}}$$

The above equation is the specific speed equation for a pump. It is defined as a “*speed of a geometrically similar machine discharging 1 m³/s of water under a head of 1m*”

Specific Speed of a Turbine

The specific speed of a turbine (Ω) is obtained by the combination of head coefficient and power coefficient as follows.

$$\pi_6 = \frac{(\pi_3)^{1/2}}{(\pi_2)^{5/4}} = \frac{P^{1/2}}{(\rho N^3 D^5)^{1/2}} \times \frac{(N^2 D^2)^{5/4}}{(gH)^{5/4}} = \frac{NP^{1/2}}{\rho^{1/2}(gH)^{5/4}}$$

But for the incompressible fluid, the term $\frac{1}{\rho^{1/2}(gH)^{5/4}}$ is dropped off as constant

Then the specific speed becomes

$$N_s = \frac{N\sqrt{P}}{H^{5/4}}$$

The above equation is the specific speed equation for a turbine. It is defined as a “*speed of a geometrically similar machine which produces 1 KW power under a head of 1m*”

Application of First and Second Laws to Turbo Machines

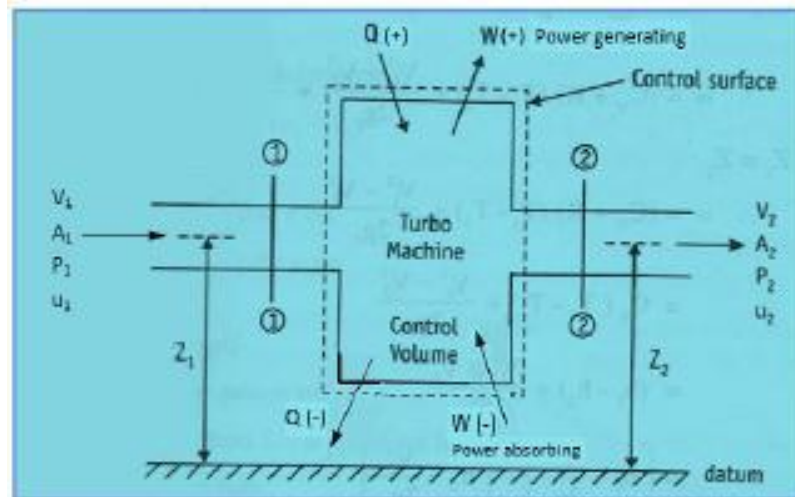

Fig 1.2 Steady flow energy process in turbo machine

STEADY FLOW ENERGY EQUATION – I Law of Thermodynamics

Taking unit mass flow rate entering the turbo machine (1 Kg) at section 1-1 and leaving at section 2-2 through control volume as shown in figure.

$$\Rightarrow u_1 + p_1 u_1 + V_1^2/2 + gZ_1 + q = w + u_2 + p_2 u_2 + V_2^2/2 + gZ_2 \quad \dots\dots (1)$$

Where,

- u = Internal Energy (J/Kg)
- p = Pressure Intensity (N/m²)
- v = Specific Volume (m³/Kg)
- V = Velocity of the fluid (m/sec)
- Z = Potential head from datum (m)
- g = Acceleration due to gravity (m/sec²)
- q = Heat transfer through control volume (J/Kg)
- w = Work done (Nm/Kg)

In a Turbo machine, during the flow process, it is assumed to be adiabatic, i.e. no heat enters or leaves the system, hence heat transfer can be neglected i.e., q = 0.

Taking $pv = RT$ and $u = C_v T$, the equation (1) becomes

$$\Rightarrow (C_v T_1 + RT_1) + V_1^2/2 + gZ_1 = w + (C_v T_2 + RT_2) + V_2^2/2 + gZ_2 \quad \dots\dots (2)$$

or

$$T_1 (C_v + R) + V_1^2/2 + gZ_1 = w + T_2 (C_v + R) + V_2^2/2 + gZ_2 \quad \dots\dots (3)$$

If the flow through the turbo machine is horizontal as shown in figure and aligned, $Z_1 = Z_2$

Hence, rearranging equation (3) it becomes

$$\Rightarrow w = (C_v + R) (T_1 - T_2) + (V_1^2 - V_2^2)/2 \quad \dots\dots (4)$$

Taking $C_p - C_v = R$, the above equation becomes

$$\Rightarrow w = C_p(T_1 - T_2) + (V_1^2 - V_2^2)/2 \quad \dots\dots (5)$$

Taking enthalpy $h = C_p T$,
 $w = (h_1 - h_2) + (V_1^2 - V_2^2)/2$ per unit mass rate

or

$$\Rightarrow w = (h_1 + V_1^2/2) - (h_2 + V_2^2/2) \quad \dots\dots (6)$$

where,
 h = Static enthalpy
 $V^2/2$ = Kinetic energy

Taking stagnation enthalpy = Static enthalpy + Kinetic energy, i.e.

$$\Rightarrow h_0 = h + V^2/2$$

The equation (6) becomes

$$\Rightarrow w = (h_{01} - h_{02}) = -\Delta h_0 \text{ [Stagnation enthalpy change]}$$

⇒ Thus, in a turbo machine, we assume that there will be kinetic energy (high velocity) during flow and no stagnation enthalpy change is considered under dynamic conditions.

⇒ In power generating turbo machines, 'w' will be positive and Δh_0 will be negative i.e., stagnation enthalpy will be decreasing from inlet to outlet of a turbo machine rotor.

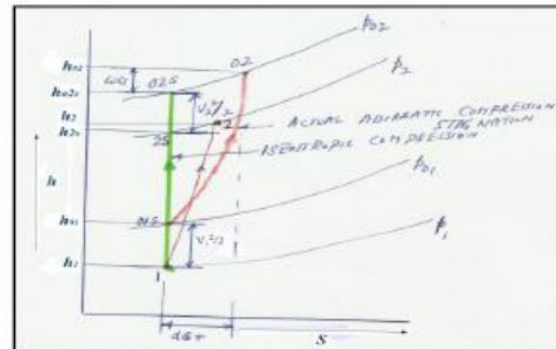
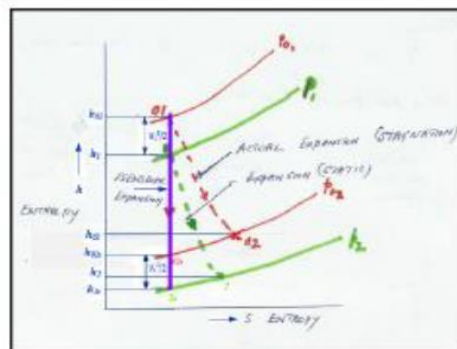
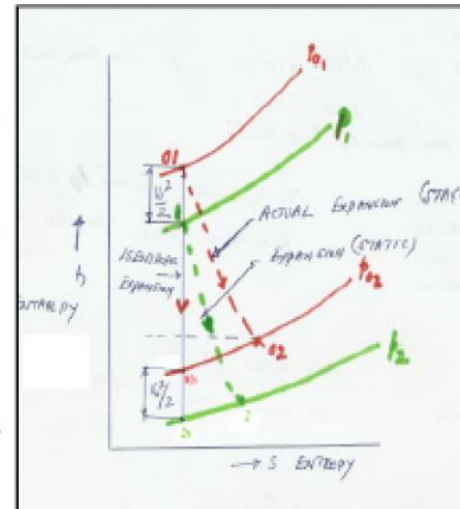

- ⇒ In a power absorbing turbo machine, 'w' will be negative and Δh_0 will be positive i.e., stagnation enthalpy will be increasing from inlet to outlet of a turbo machine rotor.
- ⇒ It should be understood that work done or enthalpy change will occur only during transfer of energy through impellers or rotors and not through stators or fixed passages.
- ⇒ Only pressure change, kinetic energy change or potential energy change will occur through stationary or stator passages depending on shape during the dynamic action of flow in the turbo machine.

THERMODYNAMICS OF FLUID FLOW

Static and Stagnation states

Turbomachines involve the use of compressible and incompressible fluids. In compressible TM's fluid move with velocities more than Mach one at many locations. In incompressible TM's the fluid velocities are generally low, however, K.E. and P.E. of the moving fluid are very large and cannot be neglected. To formulate equations based on actual state of the fluid based on laws of thermodynamics two states are used.

The states are static state and stagnation states.

Static State

If the measuring instrument is static with respect to the fluid, the measured quantity is known as static property. The measured static property could be pressure, velocity temperature, enthalpy etc. The state of the particle fixed by a set of static properties is called static state.

Stagnation State

It is defined as the terminal state of a fictitious, isentropic work-free and steady flow process during which the final macroscopic P.E. and K.E. of the fluid particle are reduced to zero.

Real process does not lead to stagnation state because no real process is isentropic. Stagnation property changes provide ideal value against which the real machine performance can be compared. It is possible to obtain stagnation properties in terms of static properties by using the definition of stagnation state. Consider the steady flow process given by the first law of thermodynamics.

$$q + \left(h_i + \frac{V_i^2}{2} + gZ_i \right) = w + \left(h_o + \frac{V_o^2}{2} + gZ_o \right)$$
$$q - w = \Delta h + \Delta ke + \Delta pe$$

Static state is the initial state in a fictitious isentropic work free, steady flow process and the stagnation state is the terminal state in which the ke and pe are reduced to zero, one can define a stagnation state at the initial static state.

$$q - w = \Delta h + \Delta ke + \Delta pe$$

$$q = 0; w = 0; ke_o = 0; pe_o = 0; \Delta h = h_o - h_i$$

$$h_o = (h_i + ke_i + pe_i) \dots 1$$

In the above eq. subscript o represents stagnation state and subscript i represents initial static state

If subscript i is removed from the initial static state

$$h_o = (h + ke + pe) \text{ --- 2}$$

Thus stagnation state has been expressed as the sum of three static properties. Since the process is isentropic, the final entropy is same as initial enthalpy. Final entropy is stagnation and initial entropy is static.

$$s_o = s \text{ --- 3}$$

Any two independent properties at a specific state is sufficient to fix the state of simple compressible substance by using thermodynamic relations.

a) Incompressible Fluid: (Density is constant)

$$T \cdot ds = dh - vdp$$

$$\text{but } ds = 0 \text{ because } s_o = s$$

$$dh = vdp$$

$$\int dh = \frac{1}{\rho} \int dp$$

Final state is stagnation with subscript o and initial state is Static without subscript

$$h_o - h = \frac{1}{\rho} (p_o - p)$$

$$p_o = \rho(h_o - h) + p$$

$$p_o = \rho(h + ke + pe - h) + p$$

$$p_o = \rho\left(\frac{V^2}{2} + gZ\right) + p$$

Thus stagnation pressure of an incompressible fluid is expressed in terms of static pressure, velocity and height above a datum line.

$$T \cdot ds = du + pdv$$

$$ds = 0 \text{ as } s_o = s$$

$$du = -pdv$$

$$dv = 0 \quad \rho = \text{constant}$$

$$\therefore du = 0; \quad u_o = u$$

$$\text{Also, } du = C_v dT$$

$$\therefore dT = 0; \quad T_o = T$$

Thus using thermodynamic relations stagnation pressure, Stagnation pressure, stagnation temperature and stagnation internal energy are found.

(b) Power Absorbing Turbomachines (PATM)

Actual work input for PATM = $h_{02} - h_{01}$

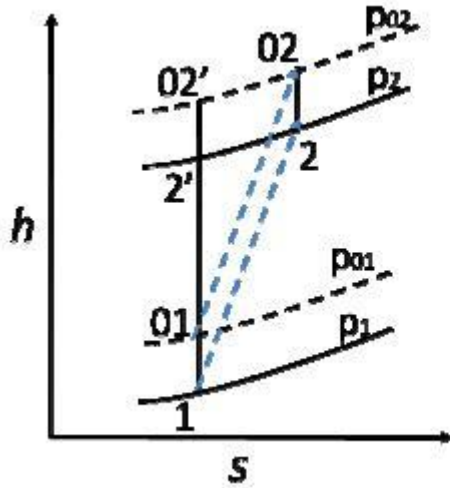

$$w_{t-t} = h_{02'} - h_{01} \quad \eta_{t-t} = \frac{h_{02'} - h_{01}}{h_{02} - h_{01}}$$

$$w_{t-s} = h_{2'} - h_{01} \quad \eta_{t-s} = \frac{h_{2'} - h_{01}}{h_{02} - h_{01}}$$

$$w_{s-t} = h_{02'} - h_1 \quad \eta_{s-t} = \frac{h_{02'} - h_1}{h_{02} - h_{01}}$$

$$w_{s-s} = h_{2'} - h_1 \quad \eta_{s-s} = \frac{h_{2'} - h_1}{h_{02} - h_{01}}$$

Finite stage efficiency

1. A stage with a finite pressure drop is a finite stage.
2. In a multi-stage turbine along with the overall isentropic efficiency the efficiencies of individual stages are important.
3. On account of large pressure drop and associated thermodynamic effect the overall isentropic efficiency is not a true index of aerodynamic or hydraulic performance of machine.
4. Different stages with the same pressure drop located in different regions of h-s plane will give different values of work output.

Effect of Reheat (Turbines)

Consider four numbers of stages between two states as shown in fig. It is assumed that the pressure ratio and stage efficiency are same for all the four stages.

Overall efficiency = _____ = _____

The actual work during expansion from state 1 to state 2 is _____

The values of ideal or isentropic work in the stages are _____

The total values of actual work done in these stages are _____

From equation 2 & equation 3

$$W_a = \eta_T W_s = \eta_{st} \sum_{i=1}^4 \Delta W_{si}$$

$$\eta_T = \eta_{st} \frac{\sum_{i=1}^4 \Delta W_{si}}{W_s} \quad \dots \quad 4$$

Infinitesimal stage efficiency or Polytropic efficiency (Turbines)

- To obtain the true aerodynamic performance of a stage the concept of smaller infinitesimal stage is used
- This is an imaginary stage with infinitesimal pressure drop and is therefore independent of reheat effect
- Fig. shows a small stage between pressures p and $p-dp$

The efficiency of this stage is

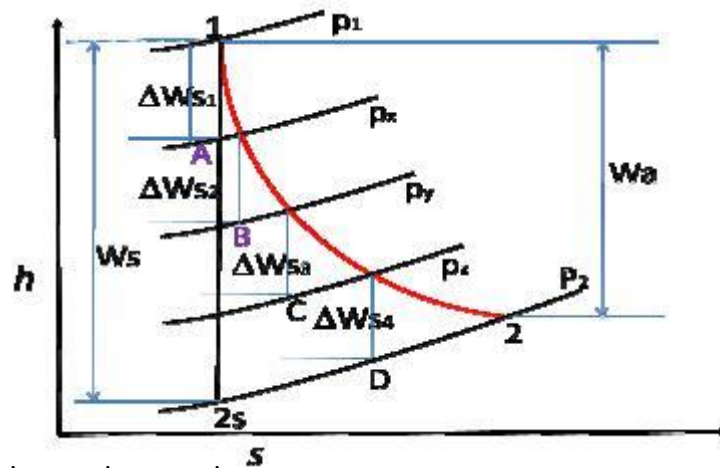

For infinitesimal isentropic expansion

$$\frac{T - dT_s}{T} = \left(\frac{p - dp}{p} \right)^{\frac{\gamma-1}{\gamma}}$$

$$1 - \frac{dT_s}{T} = \left(1 - \frac{dp}{p} \right)^{\frac{\gamma-1}{\gamma}}$$

Expanding the terms on r.h.s. using binomial expansion and neglecting terms beyond second

$$1 - \frac{dT_s}{T} = 1 - \left(\frac{\gamma-1}{\gamma} \right) \left(\frac{dp}{p} \right)$$

$$\frac{dT_s}{T} = \left(\frac{\gamma-1}{\gamma} \right) \left(\frac{dp}{p} \right)$$

$$\text{But } \eta_p = \frac{dT}{dT_s} \text{ --- 1}$$

$$\therefore \eta_p = \frac{dT}{T} \left(\frac{\gamma}{\gamma-1} \right) \left(\frac{dp}{p} \right)$$

$$\frac{dT}{T} = \left(\frac{\gamma-1}{\gamma} \right) \left(\frac{dp}{p} \right) \eta_p \text{ --- 2}$$

Integrating the eq.2 between limits 1 and 2

$$\int_{T_1}^{T_2} \frac{dT}{T} = \eta_p \left(\frac{\gamma-1}{\gamma} \right) \int_{p_1}^{p_2} \frac{dp}{p}$$

$$\log_e \frac{T_2}{T_1} = \left(\frac{\gamma-1}{\gamma} \right) \eta_p \log_e \frac{p_2}{p_1}$$

$$\eta_p = \frac{\left(\frac{\gamma}{\gamma-1} \right) \log_e \left(\frac{T_2}{T_1} \right)}{\log_e \left(\frac{p_2}{p_1} \right)} \text{--- 3}$$

$$\frac{T_2}{T_1} = \left(\frac{p_2}{p_1} \right)^{\left(\frac{\gamma-1}{\gamma} \right) \eta_p} \text{--- 4}$$

The irreversible adiabatic (actual) expansion process can be considered as equivalent to a polytropic process with index n.

$$\frac{T_2}{T_1} = \left(\frac{p_2}{p_1} \right)^{\left(\frac{\gamma-1}{\gamma} \right) \eta_p} = \left(\frac{p_2}{p_1} \right)^{\left(\frac{n-1}{n} \right)}$$

Equating indices

$$\left(\frac{\gamma-1}{\gamma} \right) \eta_p = \frac{n-1}{n}$$

$$\eta_p = \left(\frac{n-1}{n} \right) \left(\frac{\gamma}{\gamma-1} \right) \text{--- 5}$$

The index of expansion in actual process is

$$n = \frac{\gamma}{\gamma - (\gamma-1)\eta_p} \text{--- 6}$$

When $\eta_p=1$, $n=\gamma$ the expansion line coincides with the isentropic expansion. The efficiency of a finite stage can now be expressed in terms of small stage efficiency. Taking static values of T and p and assuming perfect gas

$$\eta_{st} = \frac{T_1 - T_2}{T_1 - T_{2s}}$$

$$T_1 - T_2 = T_1 \left(1 - \frac{T_2}{T_1} \right) = T_1 \left(1 - \frac{1}{(Pr)^{\frac{\gamma}{\gamma-1} \eta_p}} \right)$$

$$T_1 - T_{2s} = T_1 \left(1 - \frac{T_{2s}}{T_1} \right) = T_1 \left(1 - \frac{1}{(pr)^{\frac{\gamma-1}{\gamma}}} \right)$$

Equations 7 and 8 can give the efficiencies of various finite expansion processes with different values of pressure ratio and small stage efficiency

Finite stage efficiency (Compressor)

- A compressor with a finite pressure rise is known as a finite stage
- Stage work is a function of initial temperature and pressure ratio
- For the same pressure ratio, a stage requires a higher value of work with higher temperature
- Thus compressor stages in the higher temperature region suffer on account of this The above factors have a cumulative effect on the efficiency of multistage compressor

Effect of preheat (Compressor)

Consider a compressor with four stages as shown. It is assumed that all the stages have the same efficiencies and pressure ratios.

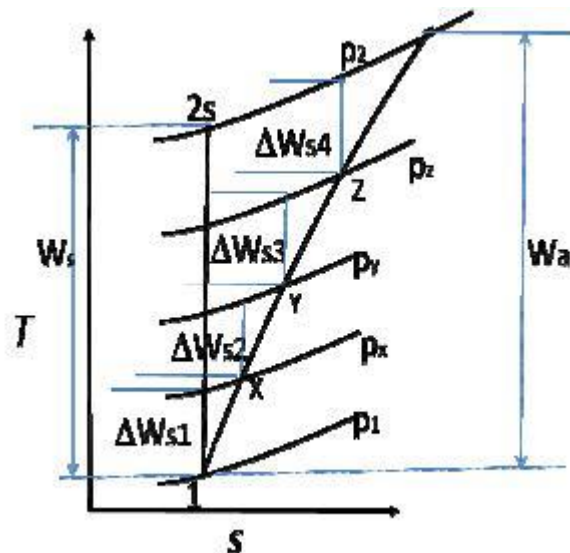

The overall efficiency of the compressor is $\eta_{st} = \frac{W_s}{W_a}$

$$\text{However } \eta_{st} = \frac{\Delta W_{s1}}{W_{1x}} = \frac{\Delta W_{s2}}{W_{xy}} = \frac{\Delta W_{s3}}{W_{yz}} = \frac{\Delta W_{s4}}{W_{z2}}$$

$$W_a = \frac{1}{\eta_{st}} \sum_{l=1}^4 \Delta W_{sl} \quad W_a = \frac{1}{\eta_{st}} (\Delta W_{s1} + \Delta W_{s2} + \Delta W_{s3} + \Delta W_{s4})$$

$$\text{but } \frac{W_s}{\sum_{l=1}^4 \Delta W_{sl}} < 1$$

This makes the overall efficiency of the compressor smaller than stage efficiency

<

This is due to the thermodynamic effect called pre-heating the gas is not intentionally heated (preheated) at the end of each compression stage. The preheat in small constant pressure processes is only an internal phenomena and the compression process still remains an adiabatic process.

Infinitesimal or Polytropic Efficiency (Compressor)

- A finite compressor stage can be made up of infinite number of small stages
- Each of these infinitesimal stages have an efficiency efficiency or infinitesimal stage efficiency
- It is independent of thermodynamic effect and is therefore the aerodynamic performance of the compressor
- Consider a stage in which air is compressed from state 1 to state 2. It also shows an infinite stage operating between pressures +

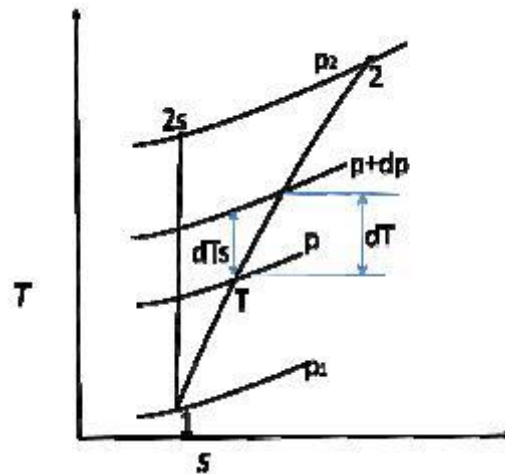

$$\eta_p = \frac{dT_s}{dT} - 1$$

$$\frac{T + dT_s}{T} = \left(\frac{p + dp}{p} \right)^{\frac{\gamma-1}{\gamma}}$$

$$1 + \frac{dT_s}{T} = \left(1 + \frac{dp}{p} \right)^{\frac{\gamma-1}{\gamma}}$$

using binomial expansion

$$1 + \frac{dT_s}{T} = 1 + \left(\frac{\gamma-1}{\gamma} \right) \frac{dp}{p}$$

$$\frac{dT_s}{T} = \left(\frac{\gamma-1}{\gamma} \right) \frac{dp}{p}$$

Substituting the value of dTs into equation 1

$$\eta_p \frac{dT}{T} = \left(\frac{\gamma-1}{\gamma} \right) \left(\frac{dp}{p} \right)$$

$$\frac{dT}{T} = \left(\frac{\gamma-1}{\gamma} \right) \left(\frac{dp}{p} \right) \times \frac{1}{\eta_p} \quad \text{---2}$$

Integrating eq.2 between state 1 to 2

$$\log_e \frac{T_2}{T_1} = \left(\frac{\gamma-1}{\gamma} \right) \frac{1}{\eta_p} \log_e \frac{p_2}{p_1} \quad \text{or} \quad \eta_p = \frac{\left(\frac{\gamma-1}{\gamma} \right) \log_e \frac{p_2}{p_1}}{\log_e \frac{T_2}{T_1}} \quad \text{--- 3}$$

Assuming the irreversible adiabatic compression as equivalent to a polytropic process with index n, equation 3 can be written as

$$\left(\frac{p_1}{p_2} \right)^{\frac{\gamma-1}{\gamma \eta_p}} = \left(\frac{p_1}{p_2} \right)^{\frac{n-1}{n}}$$

$$\frac{\gamma-1}{\gamma \eta_p} = \frac{n-1}{n}$$

$$\eta_p = \frac{\gamma-1}{\gamma} \times \frac{n}{n-1} = \frac{\gamma \eta_p}{1-\gamma(1-\eta_p)} \quad \text{--- 4}$$

The efficiency of finite compressor stage can be related to small stage efficiency. The actual temperature rise is given by

$$T_2 - T_1 = T_1 \left(\frac{T_2}{T_1} - 1 \right) = T_1 \left(pr^{\frac{\gamma-1}{\gamma \eta_p}} - 1 \right) \quad \text{where } pr = \frac{p_2}{p_1}$$

$$\eta_{st} = \frac{T_{2s} - T_1}{T_2 - T_1} = \frac{\left(\frac{T_{2s}}{T_1} - 1 \right)}{\left(\frac{T_2}{T_1} - 1 \right)} = \frac{pr^{\frac{\gamma-1}{\gamma}} - 1}{pr^{\frac{\gamma-1}{\gamma \eta_p}} - 1} \quad \text{--- 5}$$

Module: 2

ENERGY EXCHANGE IN TURBOMACHINES

Euler's turbine equation

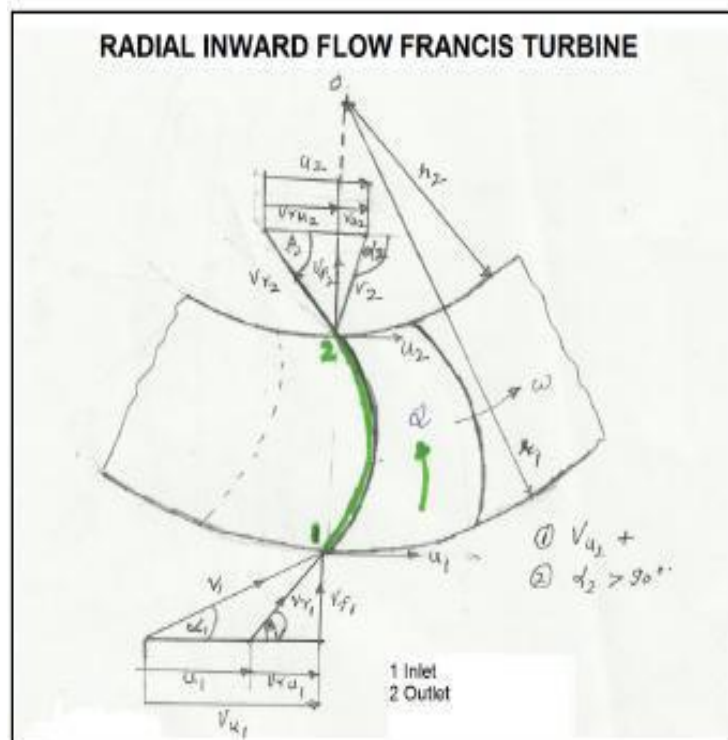
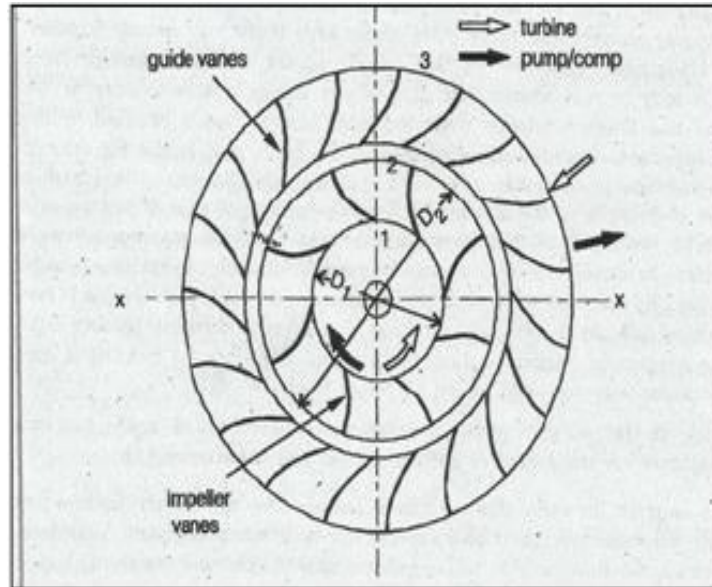

The above figure shows the velocity triangles at entry and exit of a general TM. The angular velocity of the rotor is $\dot{\omega}$ rad/sec and is given by

$$\omega = \frac{2\pi N}{60} \text{ --- 1}$$

The peripheral velocity of the blade at the entry and exit corresponding to the diameter D_1 and D_2 are given by

$$u_1 = \frac{\pi D_1 N}{60} \text{ --- 2}$$

$$u_2 = \frac{\pi D_2 N}{60} \text{ --- 3}$$

The three velocity vector V , u and V_r at the section are related by a simple vector equation

The above figure shows the velocity triangles at entry and exit of a general TM. The angular velocity of the rotor is $\dot{\omega}$ rad/sec and is given by

$$\omega = \frac{2\pi N}{60} \text{ --- 1}$$

The peripheral velocity of the blade at the entry and exit corresponding to the diameter D_1 and D_2 are given by

$$u_1 = \frac{\pi D_1 N}{60} \text{ --- 2}$$

$$u_2 = \frac{\pi D_2 N}{60} \text{ --- 3}$$

The three velocity vector V , u and V_r at the section are related by a simple vector equation

$$V = u + V_r \quad \dots 4$$

Considering unit mass of the fluid entering and leaving in unit time we have

$$\text{Angular momentum of the inlet} = V_{u1} \times R_1 \quad \dots 5$$

Similarly

$$\text{Angular momentum of the outlet} = V_{u2} \times R_2 \quad \dots 6$$

Torque produced = rate of change of Angular momentum

$$T = \{\text{Angular momentum at inlet}\} - \{\text{Angular momentum at outlet}\}$$

$$T = (V_{u1}R_1) - (V_{u2}R_2) \quad \dots 7$$

Therefore the work done is given by

$$W = \text{Torque} \times \text{angular velocity of the rotor}$$

$$\begin{aligned} W &= (V_{u1}R_1 - V_{u2}R_2)\omega \\ &= [V_{u1}(\omega R_1) - V_{u2}(\omega R_2)] \\ &= \left[V_{u1} \left(\frac{2\pi N}{60} R_1 \right) - V_{u2} \left(\frac{2\pi N}{60} R_2 \right) \right] \end{aligned}$$

$$W = \left[\frac{V_{u1}\pi D_1 N}{60} - \frac{V_{u2}\pi D_2 N}{60} \right]$$

$$W = [V_{u1}u_1 - V_{u2}u_2] \quad \dots 8$$

Alternate form of Euler's turbine equation

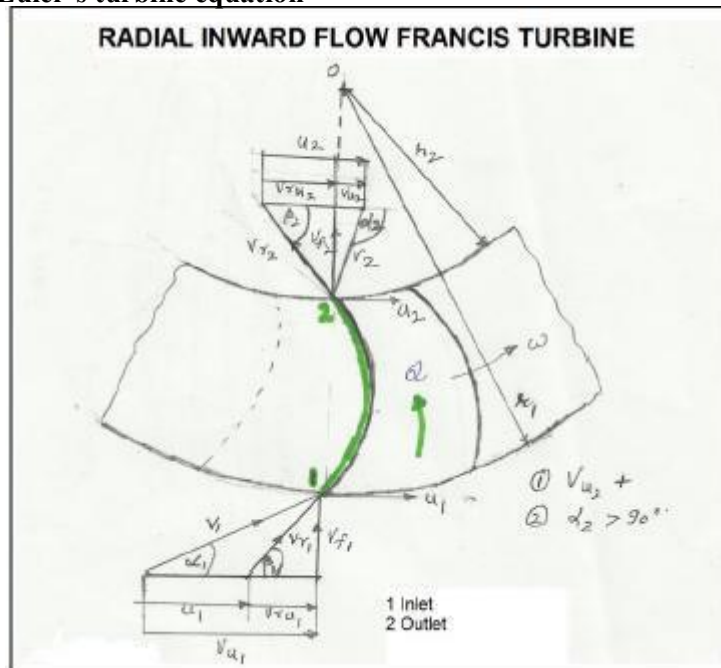

Inlet and Outlet Velocity Triangles

Referring to velocity triangles

1 – Inlet, 2 – outlet

V_1 = Absolute velocity of the fluid at inlet (before entering the rotor vanes)

V_{r1} = Relative velocity of the fluid at rotor inlet

V_{u1} = Tangential component of absolute velocity

OR

Whirl component of velocity at inlet

V_{f1} = Flow component of absolute velocity at inlet

V_{r1} = Whirl component of relative velocity at inlet

U_1 = Linear rotor vane velocity at inlet

α_1 = Absolute jet angle at inlet

β_1 = Vane (blade) angle at inlet

Referring to outlet velocity triangle

2 – Outlet

V_2 = Absolute velocity of the fluid at outlet after leaving the rotor vanes.

V_{r2} = Relative velocity of the fluid rotor outlet (Just about to leave the rotor)

V_{u2} = Whirl component of absolute velocity at outlet

V_{f2} = Flow component of absolute velocity at outlet

V_{ru2} = Whirl component of relative velocity at outlet

U_2 = Linear rotor velocity at outlet

β_1 = Fluid or jet angle at outlet (To the direction of wheel rotation)

α_1 = Vane (blade) angle at outlet (To the direction of wheel rotation)

From inlet velocity triangle

$$V_{f1}^2 = V_1^2 - V_{u1}^2$$

$$V_{r1}^2 = V_{f1}^2 + V_{ru1}^2$$

$$V_{r1}^2 = V_1^2 - V_{u1}^2 + (V_{u1} - U_1)^2$$

$$= V_1^2 - V_{u1}^2 + V_{u1}^2 - 2V_{u1}U_1 + U_1^2$$

Rearranging

$$2V_{u1}U_1 = V_1^2 + U_1^2 - V_{r1}^2$$

$$V_{u1}U_1 = \frac{V_1^2 + U_1^2 - V_{r1}^2}{2} \text{ m}^2/\text{s}^2 \text{ OR Nm/kg... (1)}$$

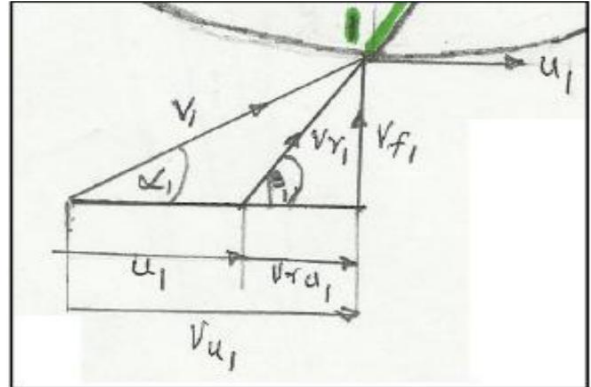

From outlet velocity triangle

$$V_{r2}^2 = V_{u2}^2 + V_{f2}^2$$

$$= (U_2 - V_{u2})^2 + (V_2^2 - V_{u2}^2)$$

Taking $V_{ru2} = (U_2 - V_{u2})$ in magnitude only and not in directions

$$V_{r2}^2 = U_2^2 - 2V_{u2}U_2 + V_{u2}^2 + V_2^2 - V_{u2}^2$$

$$\therefore V_{u2}U_2 = \frac{V_2^2 + U_2^2 - V_{r2}^2}{2} \text{ m}^2/\text{s}^2 \text{ OR Nm/kg... (2)}$$

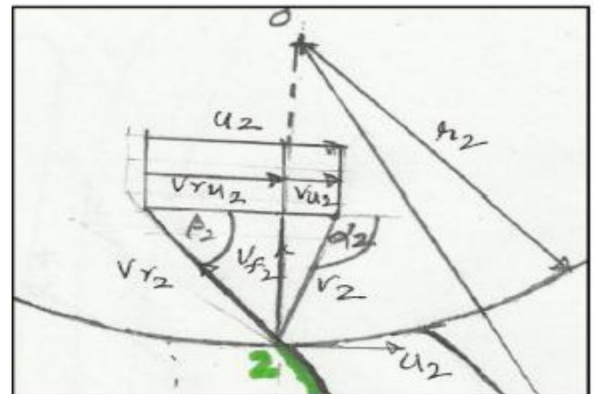

CASE 1:

Taking direction of rotation as positive

V_{u1} +ve and V_{u2} also +ve.

Work done/kg or Energy transfer in Turbine

$$\text{Work done/kg} = (V_{u1}U_1 - V_{u2}U_2)$$

$$\text{Energy Transfer (E)} = \left[\frac{V_1^2 + U_1^2 - V_{r1}^2}{2} \right] - \left[\frac{V_2^2 + U_2^2 - V_{r2}^2}{2} \right]$$

$$= \left[\frac{V_1^2 - V_2^2}{2} \right] + \left[\frac{U_1^2 - U_2^2}{2} \right] + \left[\frac{V_{r2}^2 - V_{r1}^2}{2} \right]$$

Components of energy transfer

1. $\frac{V_1^2 - V_2^2}{2}$ is change in absolute kinetic energy in m^2/s^2 or Nm/kg
2. $\frac{U_1^2 - U_2^2}{2}$ is change in centrifugal energy of fluid felt as static pressure change in rotor blades in m^2/s^2 or Nm/kg
3. $\frac{V_{r2}^2 - V_{r1}^2}{2}$ is change in relative velocity energy felt as static pressure change in rotor blades in m^2/s^2 or Nm/kg

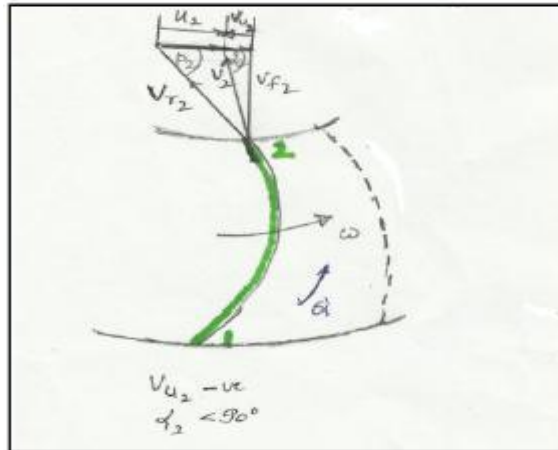

Degree of Reaction R

Degree of Reaction R is the ratio of Energy Transfer due to Static Enthalpy change to Total Energy Transfer due to Total Enthalpy change in a rotor.

$$R = \frac{\text{Static head}}{\text{Total head}} = \frac{\text{Static enthalpy change}}{\text{Total enthalpy change}} = \frac{\Delta h}{\Delta h_0}$$

$$\Delta h = \frac{V_1^2 - V_2^2}{2} + \frac{V_{r2}^2 - V_{r1}^2}{2}$$

$$\Delta h_0 = \left[\frac{V_1^2 - V_2^2}{2} \right] + \left[\frac{U_1^2 - U_2^2}{2} \right] + \left[\frac{V_{r2}^2 - V_{r1}^2}{2} \right]$$

$$R = \frac{[(U_1^2 - U_2^2) + (V_{r2}^2 - V_{r1}^2)]}{[(V_1^2 - V_2^2) + (U_1^2 - U_2^2) + (V_{r2}^2 - V_{r1}^2)]}$$

Taking

$$\left(\frac{U_1^2 - U_2^2}{2} \right) + \left(\frac{V_{r2}^2 - V_{r1}^2}{2} \right) = \text{Static component and}$$

$$\frac{V_1^2 - V_2^2}{2} = K. E \text{ Kinetic Energy Component (Absolute velocity change energies)}$$

Δh

Taking

$$\left(\frac{U_1^2 - U_2^2}{2}\right) + \left(\frac{V_{r2}^2 - V_{r1}^2}{2}\right) = S \text{ Static component and}$$

$$\frac{V_1^2 - V_2^2}{2} = K. \text{ KE Kinetic Energy Component (Absolute velocity change energies)}$$

$$R = \frac{S}{KE + S} = \frac{1}{1 + KE/S}$$

$$\left[\frac{KE}{S}\right] + 1 = \left[\frac{1}{R}\right]$$

$$\frac{KE}{S} = \frac{1}{R} - 1 = \left[\frac{1 - R}{R}\right]$$

$$S = \left[\frac{R}{1 - R}\right] KE$$

When S = Static energy felt by rotor

KE = Kinetic energy change in rotor (in terms of V1 and V2, Absolute velocities)

Effect of Blade Discharge Angle on Energy Transfer E and Degree of Reaction R

Consider an outward radial flow turbo machine as shown in figure, where 1 is inlet, 2 is outlet

Assumptions

1) Radial velocity of flow is constant, i.e.
 $V_{f1} = V_{f2} = V_f$

2) No whirl component at inlet

$$V_{u1} = 0$$

3) Diameter at outlet is twice as at inlet, i.e.
 $D_2 = 2D_1$ or $U_2 = 2U_1$

4) Blade angle at inlet = 45° , $V_1 = V_{f1} = U_1$

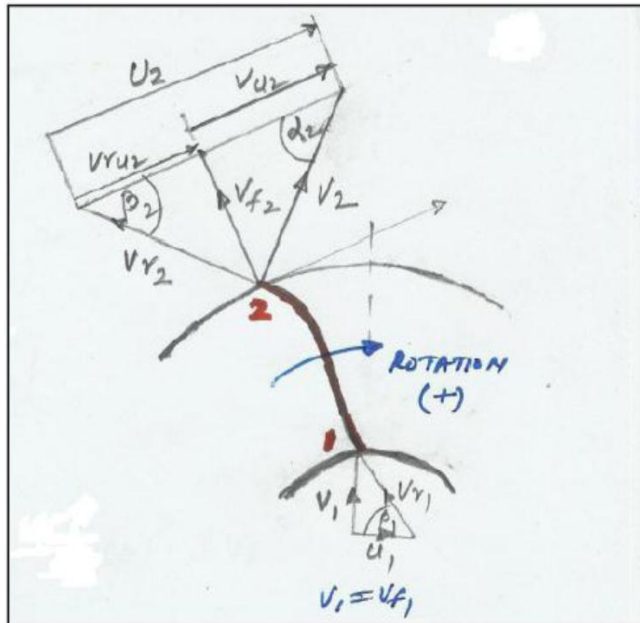

Assuming Turbine Equation

$$E = WD/kg = (V_{u1}U_1 - V_{u2}U_2)$$

$V_{u1} = 0$ as there is no whirl at inlet

$$\therefore V_{u1}U_1 = 0$$

$$E = [-V_{u2}U_2] \quad \dots \text{ Nm/kg or J/kg or m}^2/\text{sec}^2$$

Considering outlet velocity triangle,

$$E = -U_2 [U_2 - V_{r2}] \quad \text{as } \cot \beta_2 = \frac{V_{r2}}{V_{t2}}$$

$$= -U_2 [U_2 - V_{t2} \cot \beta_2]$$

From assumptions

$$V_{f1} = V_{f2} = V_f$$

$$U_2 = 2U_1 = 2V_f$$

$$E = -2V_f [2V_f - V_f \cot \beta_2]$$

$$= -2V_f^2 [2 - \cot \beta_2]$$

$$E = 2V_f^2 [\cot \beta_2 - 2] \quad \text{taking } V_f = 1 \text{ (unity) for all } \beta_2$$

$$E = 2 [\cot \beta_2 - 2] \quad \text{Nm/kg or J/kg}$$

Considering outlet velocity triangle

$$V_{r2}^2 = V_{t2}^2 + V_{u2}^2$$

$$= V_{t2}^2 + (V_{t2} \cot \beta_2)^2$$

$$= V_{t2}^2 [1 + \cot^2 \beta_2]$$

From inlet velocity triangle

$$V_{r1}^2 = V_{f1}^2 + V_{t1}^2 = 2 V_f^2$$

Degree of reaction R is given by

$$R = \frac{(U_1^2 - U_2^2) + (V_{r2}^2 - V_{r1}^2)}{2 \times E_{\text{Transfer}}}$$

Substituting for V_f

$$R = \frac{[(V_f^2 - 4V_f^2) + V_f^2 (1 + \cot^2 \beta_2) - 2V_f^2]}{2 \times 2V_f (\cot \beta_2 - 2)}$$

$$= \frac{-5V_f^2 + V_f^2 + V_f^2 \cot^2 \beta_2}{4V_f^2 (\cot \beta_2 - 2)}$$

$$= \frac{V_f^2 [\cot^2 \beta_2 - 4]}{4V_f^2 (\cot \beta_2 - 2)} \quad \text{Taking } V_f = \text{Unity}$$

$$= \frac{\cot^2 \beta_2 - 4}{4 (\cot \beta_2 - 2)}$$

$$= \frac{(\cot \beta_2 - 2) (\cot \beta_2 + 2)}{4 (\cot \beta_2 - 2)}$$

$$R = \frac{\cot \beta_2 + 2}{4}$$

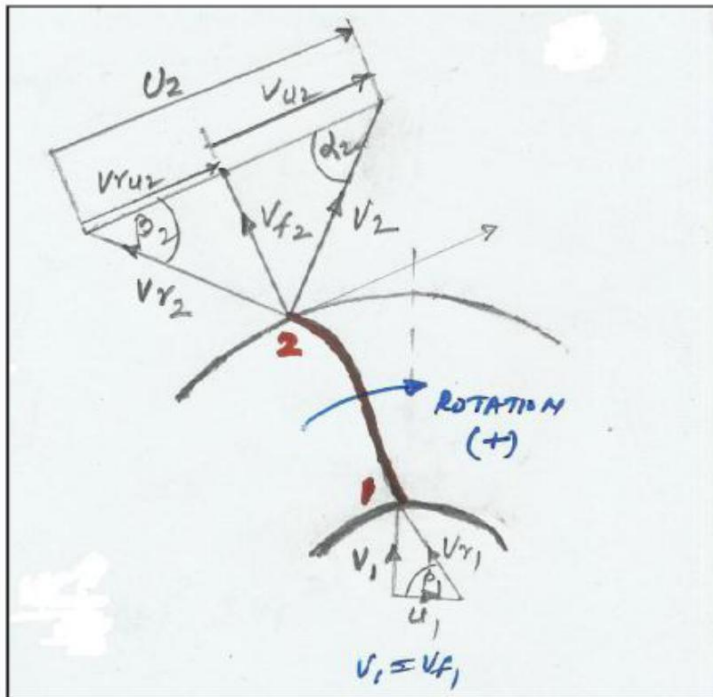

Degree of Reaction R

$$R = \frac{(\Delta p)_{\text{static}}}{(\Delta p)_{\text{stagnation}}}$$

$$R = \frac{V_{u2}U_2 - \frac{(V_2^2 - V_1^2)}{2}}{V_{u2}U_2}$$

$$R = \frac{V_{u2}U_2 - \left[\frac{(V_{f2}^2 + V_{u2}^2) - V_{f1}^2}{2} \right]}{V_{u2}U_2}$$

$$= 1 - \left[\frac{V_{u2}^2}{2V_{u2}U_2} \right]$$

$$R = 1 - \frac{V_{u2}}{2U_2}$$

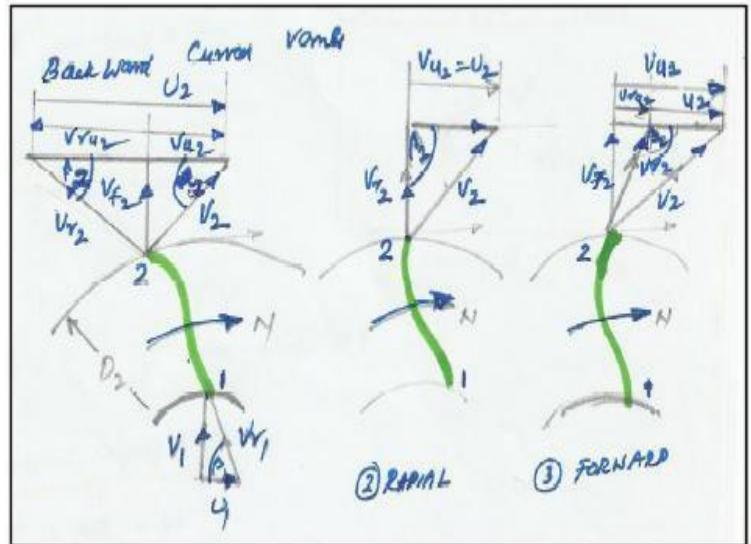

From velocity triangle at outlet for various

1. When $b_2 < 90^\circ$ backward curved vane

$$V_{u2} < U_2$$

$$R < 1 > 0.5$$

2. For Radial blades $b_2 = 90^\circ$

$$V_{u2} = U_2$$

$$R = 1 - \frac{1}{2} = 0.5$$

3. For forward curved vanes $b_2 > 90^\circ$

$$V_{u2} > U_2$$

$$R < 0.5$$

GENERAL ANALYSIS OF TURBOMACHINES

Axial flow compressors and pumps

Axial flow compressors and pumps are power absorbing turbomachines. These machines absorb external power and thereby increase the enthalpy of the flowing fluid. Axial flow turbomachines use large quantity of fluid compared to mixed and centrifugal type of turbomachines. However, the pressure rise per stage is lower in case of axial flow turbomachines than mixed and centrifugal flow turbomachines. Axial flow compressors are used in aircraft engines, stand alone power generation units, marine engines etc.

Design of axial flow compressors is more critical than the design of turbines (power generating turbomachines). The reason is that, in compressors the flow moves in the direction of increasing pressure (adverse pressure gradient). If the flow is pressurized by supplying more power, the boundary layers attached to the blades and casing get detached and reverse flow starts which lead to flow instability leading to possible failure of the machine. However, in turbines the fluid moves in the decreasing pressure (favorable pressure gradient). To transfer a given amount of energy more number of stages is required in compressors than in turbines. Generally, the fluid turning angles are limited to 20° in compressors and are 150° to 165° in case of turbines. Thus the pressure rise per stage is limited in case of compressors. Fluid flows in direction of increasing pressure, this increases the density of the fluid, and thus the height of the blade decreases from the entrance to the exit. Axial flow compressors have inlet guide vanes at the entrance and diffuser at the exit.

Figure 1 shows the flow through the compressor and fig. 2 shows the corresponding inlet and exit velocity triangles. Generally for a compressor the angles are defined with respect to axial direction (known as air angles). It can be seen that the fluid turning angle is low in case of compressors. Figure 3 shows the flow through the turbine blade and fig. 4 the corresponding inlet and exit velocity triangles for a turbine.

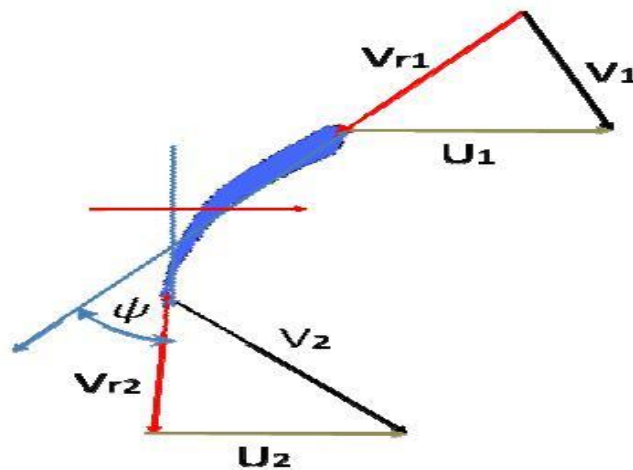

Fig. 1 Flow across a compressor blade

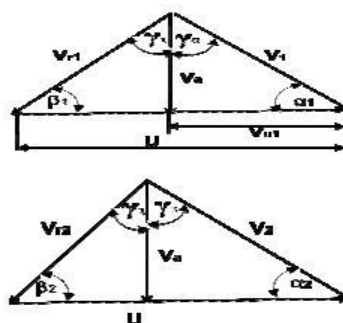

Fig. 2 Inlet and exit velocity triangles

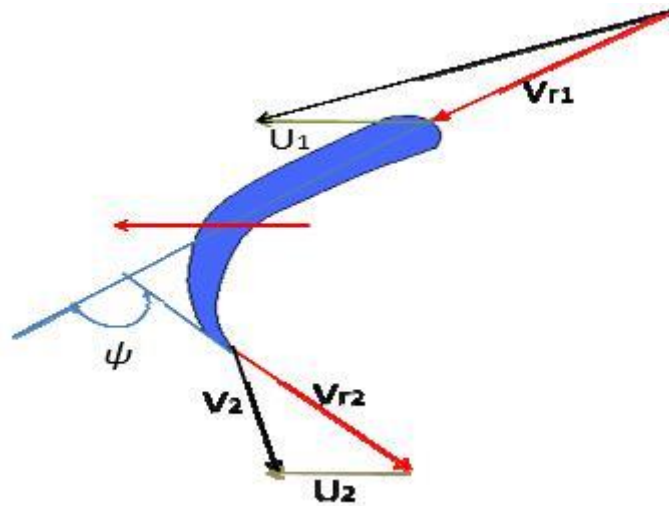

Fig. 3 Flow across a turbine blade

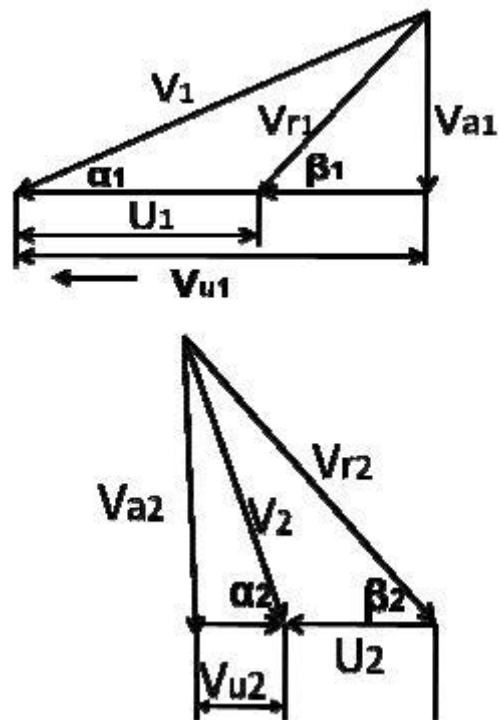

Fig. 4 Inlet and exit velocity triangles for turbine

Expression for degree of reaction for axial flow compressor

Degree of reaction is defined as a measure of static enthalpy rise that occurs in the rotor expressed as a percentage of the total static enthalpy across the rotor.

Assumptions:

- The analysis is for 2-dimensional flow. The flow is assumed to take peripheral
- velocities at inlet and outlet are same and there is no flow in the radial direction
- It is common to express blade angles w.r.t. axial direction in case of axial flow compressor (air angles)
- Axial velocity is assumed to remain constant

Figure 2 shows the inlet and exit velocity triangles for axial flow compressors. The work done on the compressor = change in stagnation enthalpy

For an axial flows TM, from inlet velocity triangle

$$U = V_a \tan \gamma_1 + V_a \tan \gamma_0 = V_a (\tan \gamma_1 + \tan \gamma_0) \quad \text{---2}$$

Similar from the exit velocity triangle

$$U = V_a (\tan \gamma_2 + \tan \gamma_3) \quad \text{---3}$$

Equating equ. 2 and equ 3 and simplifying

$$\tan \gamma_1 - \tan \gamma_2 = \tan \gamma_3 - \tan \gamma_0 \quad \text{---4}$$

$$R = \frac{V_{r1}^2 - V_{r2}^2}{2(h_{02} - h_{01})} \quad \text{---5}$$

$$V_{r1}^2 - V_{r2}^2 = V_a^2 (\tan^2 \gamma_1 - \tan^2 \gamma_2) \quad \text{---6}$$

$$h_{02} - h_{01} = U(V_{u2} - V_{u1})$$

$$V_{u2} = V_a \tan \gamma_3 \quad \text{and} \quad V_{u1} = V_a \tan \gamma_0$$

$$\Delta h_0 = UV_a (\tan \gamma_3 - \tan \gamma_0) \quad \text{---7}$$

Substuting eq. 6 and eq.7 in eq. 5

$$R = \frac{V_a^2 (\tan^2 \gamma_1 - \tan^2 \gamma_2)}{2UV_a (\tan \gamma_3 - \tan \gamma_0)}$$

$$\tan \gamma_1 - \tan \gamma_2 = \tan \gamma_3 - \tan \gamma_0 \quad \text{---4}$$

$$R = \frac{V_a^2 (\tan^2 \gamma_1 - \tan^2 \gamma_2)}{2UV_a (\tan \gamma_1 - \tan \gamma_2)}$$

$$R = \frac{V_a (\tan \gamma_1 + \tan \gamma_2)}{2U} \quad \text{---8}$$

$$R = \frac{V_a}{2U} (\cot \beta_1 + \cot \beta_2) \quad \text{---9}$$

$$R = \frac{V_a}{2U} \left(\frac{1}{\tan \beta_1} + \frac{1}{\tan \beta_2} \right)$$

$$R = \frac{V_a}{2U} \left(\frac{\tan \beta_1 + \tan \beta_2}{\tan \beta_1 \tan \beta_2} \right) \quad \text{---10}$$

Velocity triangles for different values of degree of reaction

Velocity triangles are drawn for axial flow turbo machines in which

=

- (1) When $R < 0$
 R becomes negative when $c_{1r} > c_{2r}$
 E or W_D can be positive

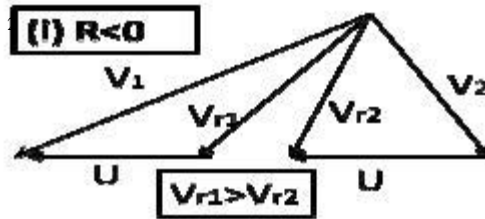

- (2) When $R=0$; $c_{1r} > c_{2r}$; impulse TM; No static pressure change across rotor

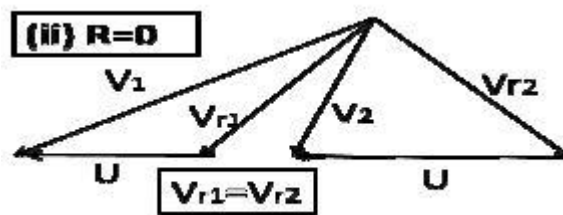

- (3) When $R=0.5$; $c_{1r} = c_{2r}$; Impulse TM; 50% by impulse and 50% by reaction, Symmetrical velocity triangle; $c_{1r} = c_{2r}$; $c_{1t} = c_{2t}$

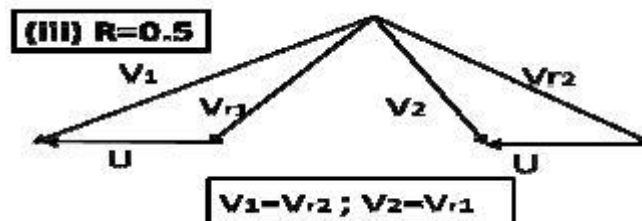

- (4) When $R=1$; $c_{1r} = c_{2r}$; purely reaction TM; energy transformation occurs purely due to change in relative K.E of fluid

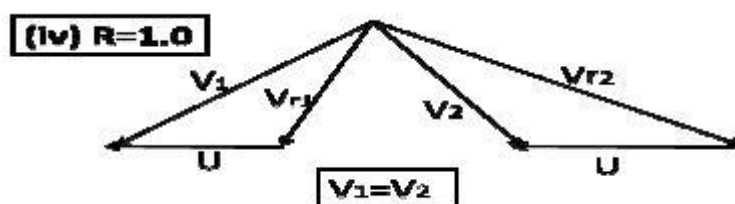

(5) When $\lambda > 1.0$; $\lambda_2 > \lambda_1$; energy transformation can be negative or positive

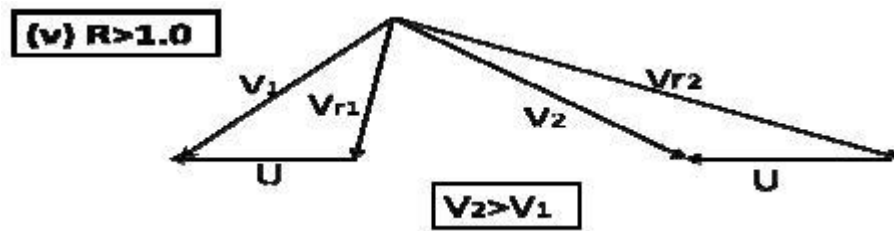

Turbines- Utilization factor

1. Utilization factor is defined only for PGTM- Turbines
2. Adiabatic efficiency is the quantity of interest in turbines
3. Overall efficiency is product of adiabatic efficiency and Mechanical efficiency
4. Mechanical efficiency of majority of TM's is nearly 100%
5. Therefore, overall efficiency is almost equal to adiabatic efficiency
6. However, adiabatic efficiency is product of utilization factor (diagram energy that can be obtained from a turbine efficiency) and efficiency associated with various losses
7. Utilization factor deals with what is maximum obtained from a turbine without considering the losses in the turbine
8. Utilization factor is the ratio of ideal work for conversion to work
9. Under ideal conditions it should be possible to utilize all the K.E. at inlet and increase the K.E. due to reaction effect
10. The ideal energy available for conversion into work

$$W_a = \frac{[V_1^2 + (U_1^2 - U_2^2) - (V_{r1}^2 - V_{r2}^2)]}{2}$$

11. The work output given by Euler's Turbine Equation is

$$W = \frac{[(V_1^2 - V_2^2) + (U_1^2 - U_2^2) - (V_{r1}^2 - V_{r2}^2)]}{2}$$

12. Utilization factor is given by

$$\epsilon = \frac{W}{W_a} = \frac{[(V_1^2 - V_2^2) + (U_1^2 - U_2^2) - (V_{r1}^2 - V_{r2}^2)]}{[V_1^2 + (U_1^2 - U_2^2) - (V_{r1}^2 - V_{r2}^2)]}$$

13. Utilization factor for modern TM's is between 90% to 95%

Relation between utilization factor and degree of reaction

Utilization factor is given by

$$\epsilon = \frac{W}{W_a} = \frac{[(V_1^2 - V_2^2) + (U_1^2 - U_2^2) - (V_{r1}^2 - V_{r2}^2)]}{[V_1^2 + (U_1^2 - U_2^2) - (V_{r1}^2 - V_{r2}^2)]}$$

The degree of reaction is given by

$$R = \frac{(U_1^2 - U_2^2) - (V_{r1}^2 - V_{r2}^2)}{(V_1^2 - V_2^2) + (U_1^2 - U_2^2) - (V_{r1}^2 - V_{r2}^2)} = \frac{(U_1^2 - U_2^2) - (V_{r1}^2 - V_{r2}^2)}{2 \times E}$$

$$X = (U_1^2 - U_2^2) - (V_{r1}^2 - V_{r2}^2)$$

$$R = \frac{X}{(V_1^2 - V_2^2) + X}$$

$$X = \frac{R(V_1^2 - V_2^2)}{1 - R}$$

Substituting the value of X in the expression for utilization factor and simplifying

$$\epsilon = \frac{(V_1^2 - V_2^2)}{(V_1^2 - RV_2^2)}$$

The above equation is valid for single rotor under the conditions where Euler's turbine equations are valid. The above equation is invalid when $R = 1$. The above equation is valid in the following range of $R = 0 \leq R < 1$.

Maximum Utilization factor

Utilization factor is given by

$$\epsilon = \frac{(V_1^2 - V_2^2)}{(V_1^2 - RV_2^2)}$$

Utilization factor maximum if the exit absolute velocity is minimum. This is possible when the exit absolute velocity is in axial direction

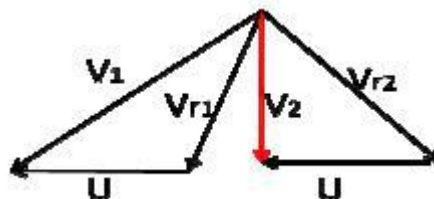

$$V_2 = V_1 \sin \alpha_1$$

$$\epsilon_m = \frac{V_1^2 - V_1^2 \sin^2 \alpha_1}{V_1^2 - R V_1^2 \sin^2 \alpha_1}$$

$$\epsilon_m = \frac{\cos^2 \alpha_1}{1 - R \sin^2 \alpha_1}$$

Maximum utilization factor is given by

$$\epsilon_m = \frac{\cos^2 \alpha_1}{1 - R \sin^2 \alpha_1} \quad \epsilon_m = 1 \text{ when } \alpha_1 = 0$$

Maximum Utilization factor for impulse turbine

For an impulse turbine $R = 0$, thus $\epsilon_m = \cos^2 \alpha_1$

From the velocity triangles OAB and OBD are similar.

Thus $AB = U$

α_1 is made as small as possible (15° to 20°)

Maximum Utilization factor for 50% reaction turbines

50% reaction turbines have; $\alpha_1 = \beta_2$; $\alpha_2 = \beta_1$ and for maximum utilization α_2 must be in axial direction. The corresponding velocity triangles are

$$V_1 \cos \alpha_1 = U + U = 2U$$

$$\frac{U}{V_1} = \frac{\cos \alpha_1}{2} = \text{Speed Ratio} = \phi$$

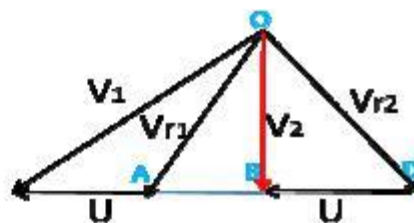

$$\epsilon_m = \frac{\cos^2 \alpha_1}{1 - R \sin^2 \alpha_1}$$

$$R = 0.5, \quad \epsilon_m = \frac{\cos^2 \alpha_1}{1 - 0.5 \sin^2 \alpha_1}$$

$$\text{Also, } V_1 \cos \alpha_1 = U$$

$$\frac{U}{V_1} = \cos \alpha_1 = \phi = \text{speed ratio}$$

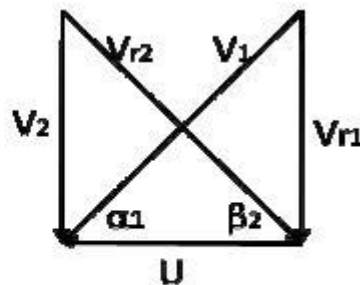

Comparison between Impulse and 50% reaction turbine maximum utilization

(a) When both have same blade speed

Let U_I and U_R be the blade speeds of impulse and 50% reaction turbines. The velocity triangles for maximum utilization are

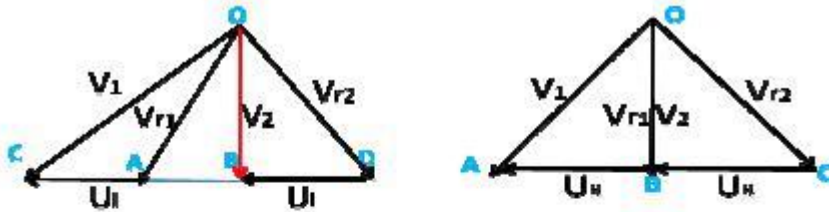

$$E_I = U_I V_{u1}$$

From velocity triangle $V_{u1} = 2U_I$

$$E_I = 2U_I^2 \text{ --- 1}$$

For 50% reaction turbine

$$E_R = U_R V_{u1}$$

But $V_{u1} = U_R$

$$E_R = U_R^2 \text{ --- 2}$$

Comparing eq. 1 and 2, it is clear that impulse turbine of energy per unit mass than 50% reaction turbine utilization is maximum.

- However, 50% reaction turbines are more efficient than impulse turbines
- But 50% reaction turbines transfer half the en turbines.
- If only 50% reaction turbines are used more stages are required or if only impulse turbines are used stages are less but efficiency is low
- In steam turbines where large pressure ratio is available it is common to use one or two impulse stages followed by reaction stages

Module: 3

STEAM TURBINES

Introduction:

Steam turbines use the steam as a working fluid. In steam turbines, high pressure steam from the boiler is expanded in nozzle, in which the enthalpy of steam being converted into kinetic energy. Thus, the steam at high velocity at the exit of nozzle impinges over the moving blades (rotor) which cause to change the flow direction of steam and thus cause a tangential force on the rotor blades. Due to this dynamic action between the rotor and the

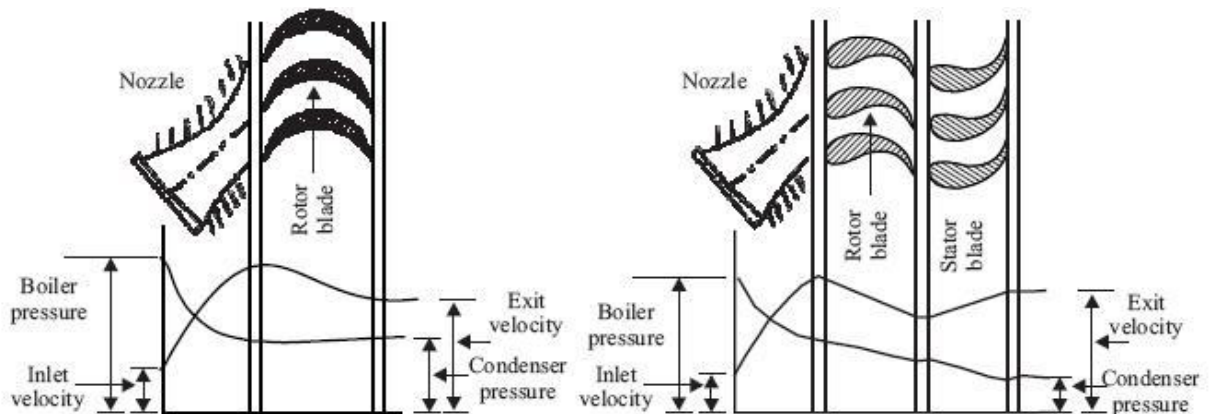

Fig.1 Impulse turbine

Fig.2 Reaction turbine

steam, thus the work is developed. These machines may be of axial or radial flow type devices.

Steam turbines may be of two kinds, namely, (i) impulse turbine and (ii) Reaction turbine.

In Impulse turbine, the whole enthalpy drop (pressure drop) occurs in the nozzle itself. Hence pressure remains constant when the fluids pass over the rotor blades. Fig.1 shows the schematic diagram of Impulse turbine.

In Reaction turbines, in addition to the pressure drop in the nozzle there will also be pressure drop occur when the fluid passes over the rotor blades.

Most of the steam turbine is of axial flow type devices except Ljungstrom turbine which is a radial type.

Compounding of Steam Turbines:

If only one stage, comprising of single nozzle and single row of moving blades, is used, then the flow energy or kinetic energy available at inlet of machine is not absorbed fully by one row of moving blades running at half of absolute velocity of steam entering the stage (because, even for maximum utilization, $U/V = \sin \alpha = 1/2$). It means to say that, due to high rotational speed all the available energy at inlet of machine is not utilized which being simply wasted at exit of machine. Also we know that for maximum utilization, exit velocity of steam should be minimum or negligible. Hence, for better utilization, one has to have a reasonable tangential speed of rotor. In order to achieve this, we have to use, two or more rows of moving blades with a row of stationary blades between every pair of them. Now, the total energy of steam available at inlet of machine can be absorbed by all the rows in succession until the kinetic energy of steam at the end of the last row becomes negligible.

Hence Compounding can be defined "as the method of obtaining reasonable tangential speed of rotor for a given overall pressure drop by using more than one stage"

Compounding is necessary for steam turbines because if the tangential blades tip velocity greater than 400 m/s, then the blade tips are subjected to centrifugal stress. Due this, utilization is low hence the efficiency of the stage is also low. Compounding can be done by the following methods, namely, (i) Velocity compounding, (ii) Pressure compounding or Rateau stage (iii) Pressure-Velocity compounding and (iv) Impulse- Reaction staging.

1. Velocity Compounding (Curtis Stage) of Impulse Turbine :

This consists of set of nozzles, rows of moving blades (rotor) & a row of stationary blades (stator). Fig.3 shows the corresponding velocity compounding Impulse Turbine.

The function of stationary blades is to direct the steam coming from the first moving row to the next moving row without appreciable change in velocity. All the kinetic energy available at the nozzle exit is successively absorbed by all the moving rows & the steam is sent from the last moving row with low velocity to achieve high utilization. The turbine works under this type of compounding stage is called velocity compounded turbine. E.g. **Curtis stage steam turbine**

2. Pressure Compounded (Rateau Stage) Impulse Turbine :

A number of simple impulse stages arranged in series is called as pressure compounding. In this case, the turbine is provided with rows of fixed blades which act as a nozzle at the entry of each row of moving blades. The total pressure drop of steam does not take place in a single nozzle but divided among all the rows of fixed blades which act as nozzle for the next moving rows. Fig.4 shows the corresponding pressure compounding Impulse turbine.

Pressure compounding leads to higher efficiencies because very high flow velocities are avoided through the use of purely convergent nozzles. For maximum utilization, the absolute

velocity of steam at the outlet of the last rotor must be axially directed. It is usual in large turbines to have pressure compounded or reaction stages after the velocity compounded stage.

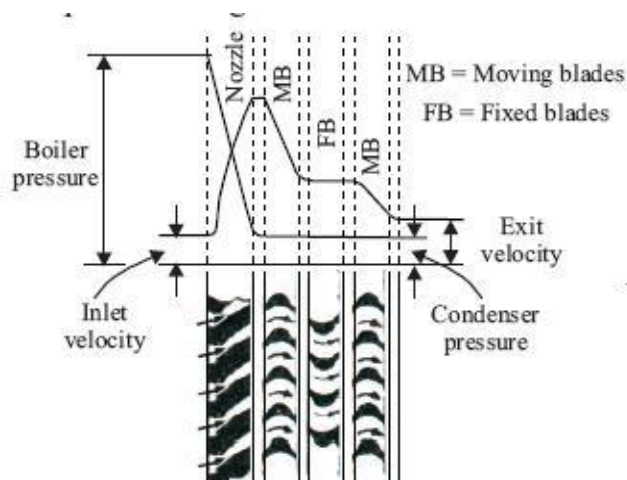

Fig.3 Velocity compounded impulse turbine

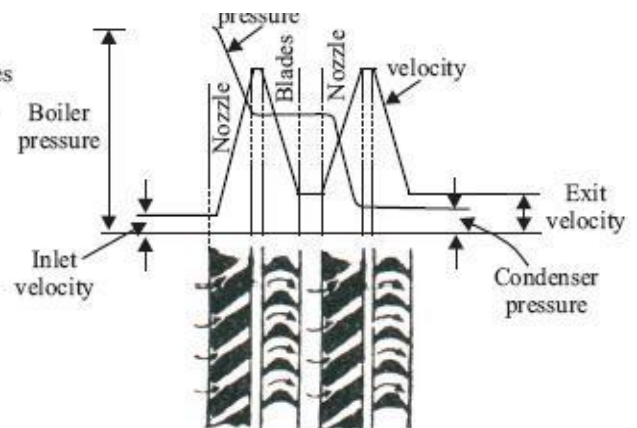

Fig.4 Pressure compounded impulse turbine

3. Pressure -Velocity Compounding:

In this method, high rotor speeds are reduced without sacrificing the efficiency or the output. Pressure drop from the chest pressure to the condenser pressure occurs at two stages. This type of arrangement is very popular due to simple construction as compared to pressure compounding steam turbine.

Pressure-Velocity compounding arrangement for two stages is as shown in Fig.5. First and second stage taken separately are identical to a velocity compounding consists of a set of nozzles and rows of moving blades fixed to the shaft and rows of fixed blades to casing. The entire expansion takes place in the nozzles. The high velocity steam parts with only portion of the kinetic energy in the first set of the moving blades and then passed on to fixed blades where only change in direction of jet takes place without appreciable loss in velocity. This jet then passes on to another set of moving vanes where further drop in kinetic energy occurs. This type of turbine is also called Curtis Turbine.

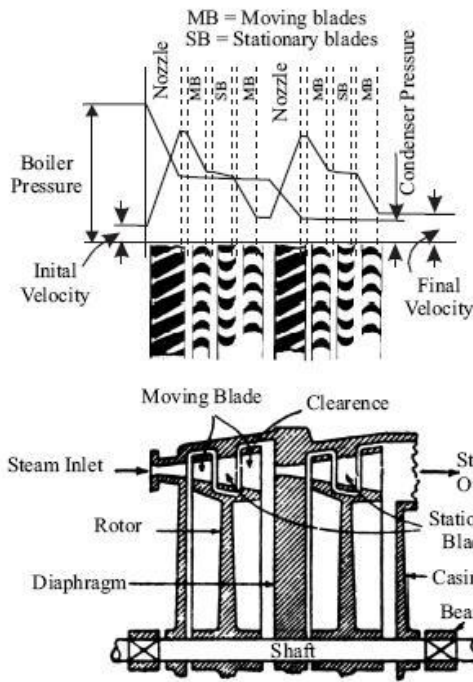

Fig.5 Pressure - Velocity compounding

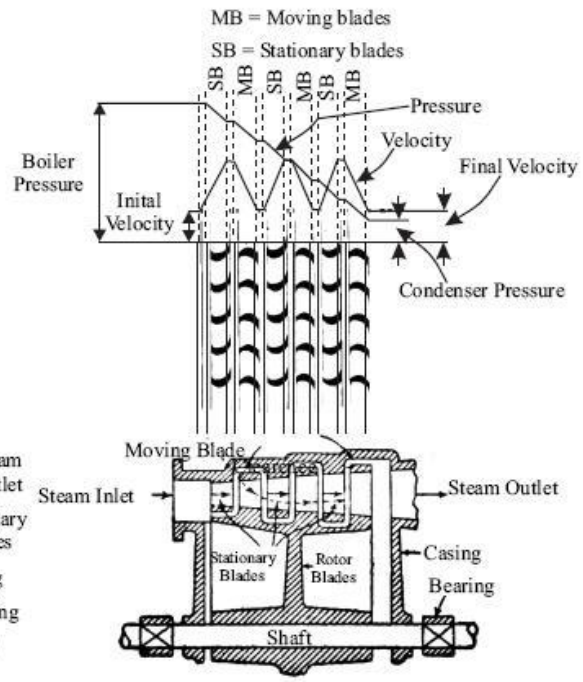

Fig.6 Impulse Reaction turbine

4. Impulse- Reaction Turbine:

In this type of turbine there is application of both principles namely impulse and reaction.

This type of turbine is shown in Fig.6. The fixed blades in this arrangement corresponding to the nozzles referred in the impulse turbine. Instead of a set of nozzles, steam is admitted for whole of the circumference. In passing through the first row of fixed blades, the steam undergoes a small drop in pressure and its velocity increases. Steam then enters the first row of moving blades as the case in impulse turbine it suffers a change in direction and therefore momentum. This gives an impulse to the blades. The pressure drop during this gives rise to reaction in the direction opposite to that of added velocity. Thus the driving force is vector summation of impulse and reaction.

Normally this turbine is known as Reaction turbine. The steam velocity in this type of turbine is comparatively low, the maximum being about equal to blade velocity. This type of turbine is very successful in practice. It is also called as Parson's Reaction turbine.

Condition for Maximum Utilization Factor or Blade efficiency with Equiangular Blades for Impulse Turbine:

Condition for maximum utilization factor or blade efficiency with equiangular blades for Impulse turbine and the influence of blade efficiency on the steam speed in a single stage Impulse turbine can be obtained by considering corresponding velocity diagrams as shown in Fig.9. Due to the effect of blade friction loss, the relative velocity at outlet is reduced than the

relative velocity at inlet. Therefore, $V_{r2} = C_b V_{r1}$, corresponding to this condition, velocity triangles (qualitative only) are drawn as shown in figure.

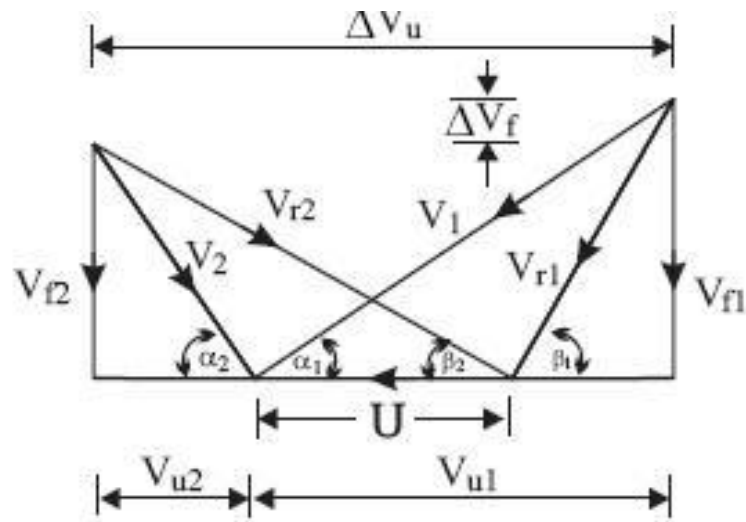

$$E = W = \frac{U(V_{u1} + V_{u2})}{g_c} = \frac{U \Delta V_u}{g_c}$$

From velocity triangle :

$$\begin{aligned} \Delta V_u &= V_{u1} + V_{u2} = V_{r1} \cos \beta_1 + V_{r2} \cos \beta_2 \\ &= V_{r1} \cos \beta_1 \left(1 + \frac{V_{r2}}{V_{r1}} \frac{\cos \beta_2}{\cos \beta_1} \right) \end{aligned}$$

But $V_{r1} \cos \beta_1 = V_1 \cos \alpha_1 - U$

$$\therefore \Delta V_u = (V_1 \cos \alpha_1 - U) [1 + (V_{r2}/V_{r1})(\cos \beta_2 / \cos \beta_1)]$$

But $\frac{V_{r2}}{V_{r1}} = C_b$ and for a given rotor, β_1 & β_2 are also fixed. Let $K = \frac{\cos \beta_2}{\cos \beta_1}$

$$\therefore \Delta V_u = (V_1 \cos \alpha_1 - U) [1 + C_b K]$$

\therefore Work done per kg of steam is,

$$W = U (V_1 \cos \alpha_1 - U) [1 + C_b K] \quad (5)$$

If we express in terms of speed ratio, $\phi = U/V_1$, we get

$$W = V_1^2 \phi [\cos \alpha_1 - \phi] (1 + C_b K) \quad (6)$$

The available energy per kg of steam at inlet is $V_1^2 / 2g_c$

$$\text{Also, blade efficiency, } \eta_b = \frac{W}{V_1^2 / 2g_c} = \frac{2\phi V_1^2 [\cos \alpha_1 - \phi] (1 + C_b K)}{V_1^2}$$

$$\eta_b = 2(\phi \cos \alpha_1 - \phi^2) (1 + C_b K) \quad (7)$$

Eqn.(7) shows that the rotor efficiency or blade efficiency varies parabolically for the given α_1, C_b and K .

For the maximum blade efficiency, $\frac{d\eta_b}{d\phi} = 0$

$$\therefore \text{Speed ratio, } \phi = \frac{\cos \alpha_1}{2} \quad (8)$$

It is same as the maximum utilization for an impulse turbine discussed in chapter-2.

The maximum blade efficiency becomes

$$\therefore \eta_{b, \max} = 2 \left(\frac{\cos^2 \alpha_1}{2} - \frac{\cos^2 \alpha_1}{4} \right) (1 + C_b K)$$

$$\eta_{b, \max} = \frac{\cos^2 \alpha_1}{2} (1 + C_b K) \quad (9)$$

Further, if rotor angles are equiangular i.e., $\beta_1 = \beta_2$ and $V_{r1} = V_{r2}$

$$\text{Then, } \eta_{b, \max} = \cos^2 \alpha_1 \quad (10)$$

It is seen that the $\eta_{b, \max}$ is same as maximum utilization for Impulse turbine when there is no loss and blades are equiangular.

Analysis on Two Stages:

Condition of Maximum Efficiency for Velocity Compounded Impulse Turbine (Curtis Turbine)

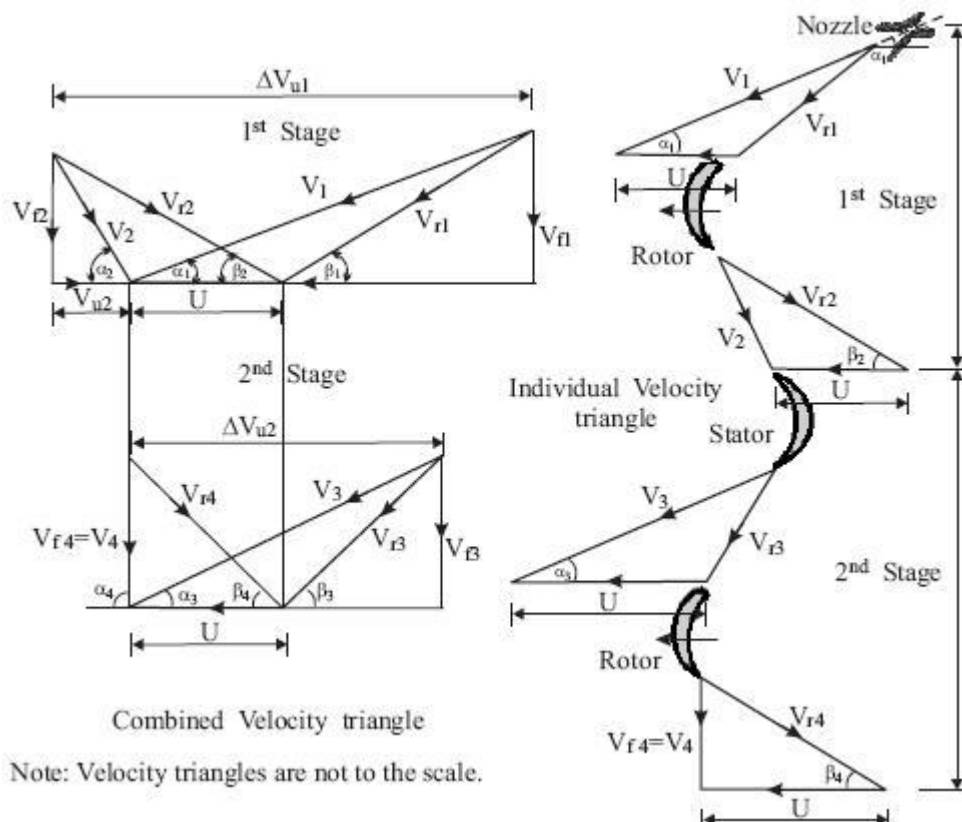

The velocity triangles for first stage and second stage of a Curtis turbine are as shown in above figure. The speed and the angles should be so selected that the final absolute velocity of steam leaving the second row is axial, so as to obtain maximum efficiency. The tangential speed of blade for both the rows is same since all the moving blades are mounted on the same shaft.

In the first row of moving blades, the work done per kg of steam is, W_1
 $= U (V_{u1} + V_{u2}) / g = UV_{u1} / g$

From I stage velocity triangle, we get, $W_1 = U (V_{r1} \cos \beta + V_{r2} \cos \beta) / g$ If $\beta_1 = \beta_2$ and $V_{r1} = V_{r2}$, then,
 $W_1 = 2U (V_{r1} \cos \beta_1) / g$

$$W_1 = 2U (V_1 \cos \alpha_1 - U) / g$$

The magnitude of the absolute velocity of steam leaving the first row is same as the velocity of steam entering the second row of moving blades, if there is no frictional loss (i.e., $V_2 = V_3$) but only the direction is going to be changed.

In the second moving row, work done per kg of steam is,

$$W_2 = U (V_{u2} + V_{u4}) / g = U (V_{r3} \cos \beta_3 + V_{r4} \cos \beta_4) / g$$

Again if $\beta_3 = \beta_4$ and $V_{r3} = V_{r4}$

$$W_2 = 2U (V_{r3} \cos \beta_3) / g$$

$$W_2 = 2U (V_3 \cos \alpha_3 - U) / g$$

If no loss in absolute velocity of steam entering from I rotor to the II rotor, then $V_3 = V_2$ & $\alpha_3 = \alpha_2$

$$W_2 = 2U (V_2 \cos \alpha_2 - U) / g$$

Also, $V_2 \cos \alpha_2 = V_{r2} \cos \beta_2 - U = V_{r1} \cos \beta_1 - U$. ($V_{r1} = V_{r2}$ & $\beta_1 = \beta_2$)

$$V_2 \cos \alpha_2 = (V_1 \cos \alpha_1 - U) - U \quad (V_{r1} \cos \beta_1 = V_1 \cos \alpha_1 - U)$$

$$V_2 \cos \alpha_2 = V_1 \cos \alpha_1 - 2U$$

$$W_2 = 2U (V_1 \cos \alpha_1 - 3U) / g$$

Total Work done per kg of steam from both the stages is given by

$$W_T = W_1 + W_2 = 2U [V_1 \cos \alpha_1 - 3U + V_1 \cos \alpha_1 - U] / g$$

$$W_T = 2U [2V_1 \cos \alpha_1 - 4U] / g$$

$$W_T = 4U [V_1 \cos \alpha_1 - 2U] / g$$

In general form, the above equation can be expressed as,

$$W = 2 n U [V_1 \cos \alpha_1 - nU] / g$$

Where, n = number of stages.

Then the blade efficiency is given by,

$$\frac{\partial \eta_b}{\partial \phi} = 8 \phi [\cos \alpha_1 - 2\phi] \Rightarrow \cos \alpha_1 - 4\phi = 0$$

$$\phi = \frac{\cos \alpha_1}{4} = U / V_1$$

And work done in the last row = $1/2^n$ of total work

V_1 = Absolute velocity of steam entering the first rotor or steam velocity at the exit of the nozzle, m/s.

α_1 = Nozzle angle with respect to wheel plane or tangential blade speed at inlet to the first rotor, degrees.

V_{r1} = Relative velocity of fluid at inlet of I stage, m/s.

β_1 = Rotor or blade angle at inlet of 1 rotor made by V_{r1} , degree
 V_{r2} = Relative velocity of fluid at outlet of I stage.

β_2 = Rotor or blade angle at outlet of I rotor made degree

V_2 = Absolute velocity of steam leaving the I rotor or stage, m/s
 α_2 = Exit angle of steam made by V_2 , degree

V_3 = Absolute velocity of steam entering the 2 rotor or exit velocity of the steam from the stator m/s.

α_3 = Exit angle of stator for 2 rotor, degree

Module: 4

HYDRAULIC TURBINES

Introduction:

Hydraulic (water) turbines are the machines which convert the water energy (Hydro power) into Mechanical energy. The water energy may be either in the form of potential energy as we find in dams, reservoirs, or in the form of kinetic energy in flowing water. The shaft of the turbine directly coupled to the electric generator which converts mechanical energy in to electrical energy. This is known as "Hydro-Electric power".

Classification of Hydraulic Turbines:

Water turbines are classified into various kinds according to i) the action of water on blades, ii) based on the direction of fluid flow through the runner and iii) the specific speed of the machine.

(i) Based on a Francis turbine Action of Water on Blades:

These may be classified into: 1) Impulse type and 2) Reaction type

In impulse turbine, the pressure of the flowing fluid over the runner is constant and generally equal to an atmospheric pressure. All the available potential energy at inlet will be completely converted into which in turn utilized through a purely impulse effect to produce work. Therefore, in impulse turbine, the available energy at the inlet of a turbine is only the kinetic energy.

In reaction turbine, the turbine casing is filled with water and the water pressure changes during flow through the rotor in addition to kinetic energy from nozzle (fixed blades). As a whole, both the pressure and are available at the inlet of reaction turbines for producing power.

(ii) Based on the direction of Flow of Fluid through Runner:

Hydraulic machines are classified into:

- a) Tangential or peripheral flow
- b) Radial inward or outward flow
- c) Mixed or diagonal flow
- d) Axial flow types.

a) Tangential Flow Machines:

In tangential flow turbines, the water flows along the tangent to the path of rotation of the runner. Example: **Pelton wheel**

b) Radial Flow Machines:

In radial flow machine, the water flows along the radial direction and flow remains normal to the axis of rotation as it passes through the runner. It may be inward flow or outward flow.

In Inward flow turbines, the water enters at the outer periphery and passes through the runner inwardly towards the axis of rotation and finally leaves at inner periphery.

Example: **Francis turbine**. In outward flow machines the flow direction is opposite to the inward flow machines.

c) Mixed or Diagonal Flow:

In this type of turbine, the flow of fluid may enter at the outer periphery, passes over the runner inwardly and leaves axially or parallel to the axis of rotation and vice-versa Examples: **Modern Francis turbine, Deriaz turbine d) Axial Flow Devices:**

In this type of turbine, the water along the direction parallel to the axis of rotation.

Examples: Kaplan turbine, propeller turbine etc.

(iii) Based on Specific Speed:

Hydraulic turbines are classified into:

(a) Low Specific Speed: Which employs high head in the range of 200m up to 1700 m

This machine requires low discharge. Examples: Pelton wheel. $NS = 10$ to 30 single jet and 30 to 50 for double jet Pelton wheel.

(b) Medium Specific Speed: Which employs moderate heads in the range of 50m to 200

m. Example: Francis turbine, $NS = 60$ to 400 .

(c) High Specific Speed: Which employs very low heads in the range of 2.5m to 50 m

These require high discharge. Examples: Kaplan, Propeller etc., $N = 300$ to 1000

PeltonWheel:

This is a impulse type of tangential flow hydraulic turbine. It mainly posses: (i) Nozzle (ii) runner and buckets (iii) casing (iv) Brake nozzle. Fig. 1 shows general layout of hydro-electric power plant with pelton wheel.

The water from the dam is made to flow through the penstock. At the end of the penstock, nozzle is fitted which convert the potential energy into high kinetic energy. The speed of the jet issuing from the nozzle can be regulated by operating the spear head by varying the flow area. The high velocity of jet impinging over the buckets due to which the runner starts rotating because of the impulse effects and thereby hydraulic energy is converted into mechanical energy. After the runner, the water falls into tail race. Casing will provide the housing for runner and is open to atmosphere. Brake nozzles are used to bring the runner from high speed to rest condition whenever it is to be stopped. In order to achieve this water is made to flow in opposite direction to that of runner.

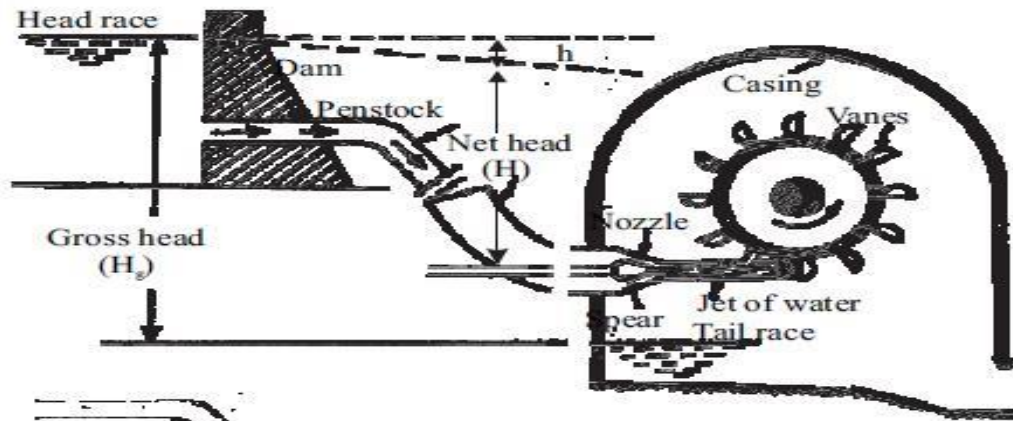

Fig.1 Layout of Hydro-electric power plant

Heads and Efficiencies of Hydraulic Turbines:

Hydraulic Heads:

- (a) **Gross head:** It is the difference between the head race and tail race level when there is no flow. As such it is termed as static head and is denoted as H_s or H_g .
- (b) **Effective head:** It is the head available at the inlet of the turbine. It is obtained by considering all head losses in penstock. If h is the total loss, then the effective head above the turbine is $H = H_g - hf$

Efficiencies:

Various efficiencies of hydraulic turbines are:

- I) Hydraulic efficiency (η_H)
- ii) volumetric efficiency (η_{Vol})
- iii) Mechanical efficiency (η_{mech})
- IV) Overall efficiency (η_O)

IV) Overall efficiency (η_o): It is the ratio of shaft output power by the turbine to the water power available at inlet of the turbine

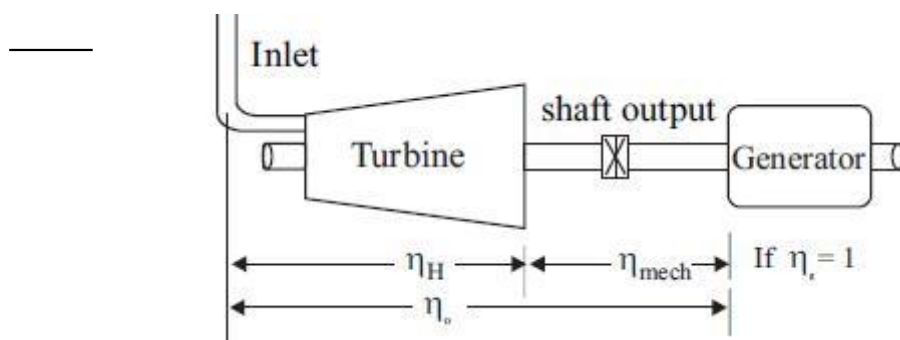

=

Work Done by the Pelton Wheel:

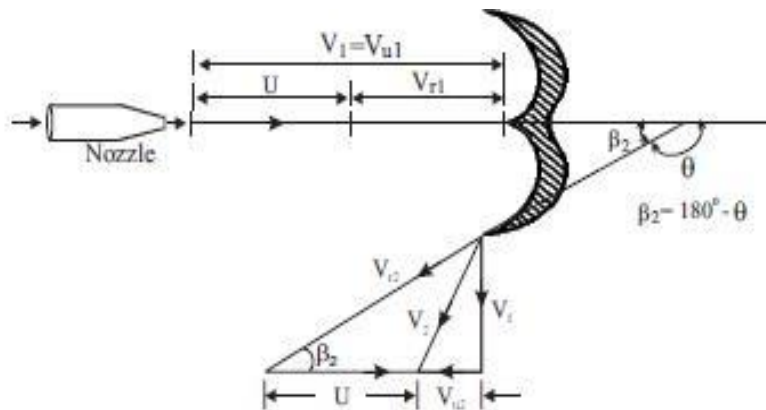

Fig 3 Shape of bucket & Velocity diagram

Where θ is the angle through which the jet is deflected by the bucket. β_2 is the runner tip angle = $180 - \theta$.

Fig. 3 shows the inlet and outlet velocity triangles. Since the angle of entrance of jet is zero, the inlet velocity triangle collapses to a straight line. The tangential component of absolute velocity at inlet $V_{u1} = V_1$ and the relative velocity at the inlet is $V_{r1} = V_1 - U$.

From the outlet velocity Δ^{le} ,

$$V_{u2} = V_{r2} \cos \beta_2 - U$$

$$= C_b V_{r1} \cos \beta_2 - U \quad (\because V_{r2} = C_b V_{r1})$$

$$V_{u2} = (V_1 - U) C_b \cos \beta_2 - U \quad (\because V_{r1} = V_1 - U)$$

Work done / kg of water by the runner

$$W = U (V_{u1} + V_{u2}) / g_c \quad (+ve \text{ sign for opposite direction of } V_{u1} \text{ and } V_{u2})$$

$$= U [V_{u1} + (V_1 - U) C_b \cos \beta_2 - U] / g_c$$

$$= U [(V_1 - U) + (V_1 - U) C_b \cos \beta_2] / g_c$$

$$W = U [(V_1 - U) (1 + C_b \cos \beta_2)] / g_c \quad (6)$$

The energy supplied to the wheel is in the form of kinetic energy of the jet which is equal to $V_1^2 / 2g_c$.

$$\text{Hydraulic efficiency, } \eta_{hi} = \frac{W}{V_1^2 / 2g_c} = \frac{U [(V_1 - U) (1 + C_b \cos \beta_2)] / g_c}{V_1^2 / 2g_c}$$

$$\eta_{hi} = \frac{2U (V_1 - U) (1 + C_b \cos \beta_2)}{V_1^2} \quad (7)$$

For maximum hydraulic efficiency, $\frac{d\eta_H}{dU} = 0$

as $\frac{2(1+C_b \cos\beta_2)}{V_1^2} \neq 0$, $V_1 - 2U = 0$

$$\therefore V_1 = 2U \text{ or } \phi = U/V_1 = 0.5$$

$$U = \frac{1}{2} V_1 = 0.5 V_1 \quad (7.8)$$

This shows that the tangential velocity of bucket should be half of the velocity of jet for maximum efficiency.

Then,

$$\eta_{H, \max} = \frac{2U(2U-U)(1+C_b \cos\beta_2)}{(2U)^2}$$

$$\eta_{H, \max} = \frac{1+C_b \cos\beta_2}{2} \quad (9)$$

If $C_b = 1$, then the above equation gives the maximum efficiency for $\beta_2 = 0^\circ$

5.1 Working Proportions of Pelton Wheel :

(i) **Ideal velocity of jet from the Nozzle**, $V_{th} = \sqrt{2gH}$ (10)

& Actual velocity of jet, $V_1 = C_v \sqrt{2gH}$

C_v = coefficient of velocity for nozzle is in the range of 0.97 to 0.99

(ii) **Tangential velocity of buckets,**

$$U = \phi \sqrt{2gH} \Rightarrow \phi = U/(\sqrt{2gH}), \quad (11)$$

Where ϕ = Speed ratio and is in the range of 0.43 to 0.48

(iii) **Least diameter of the jet, (d)₂**

$$\text{Total discharge, } Q_T = n \frac{\pi d^2}{4} V_1 = n \frac{\pi d^2}{4} C_v \sqrt{2gH} \quad (12)$$

Where n = number of jets (nozzles)

(iv) **Mean Diameter or Pitch diameter of Buckets or Runner : (D)**

$$\text{Tangential velocity, } U = \frac{\pi DN}{60} \text{ or } D = \frac{U \cdot 60}{\pi N} \quad (13)$$

(v) **Number of Buckets required (Z) :**

The ratio of mean diameter of buckets to the diameter of jet is known as "Jet Ratio". i.e., $m = D/d$.

$$\therefore Z = \frac{m}{2} + 15 = \frac{D}{2d} + 15 \text{ where } m \text{ ranges from } 6 \text{ to } 35. \quad (14)$$

Reaction Turbine:

In reaction turbines, only part of total head of water at inlet is converted into velocity head before it enters the runner and the remaining part of total head is converted in the runner as the water flows over it. In these machines, the water is completely filled in all the passages of runner. Thus, the pressure of water gradually changes as it passes through the runner. Hence, for this kind of machines both pressure energy and kinetic energy are available at inlet. E.g. Francis turbine, Kaplan turbines, Deriaz turbine.

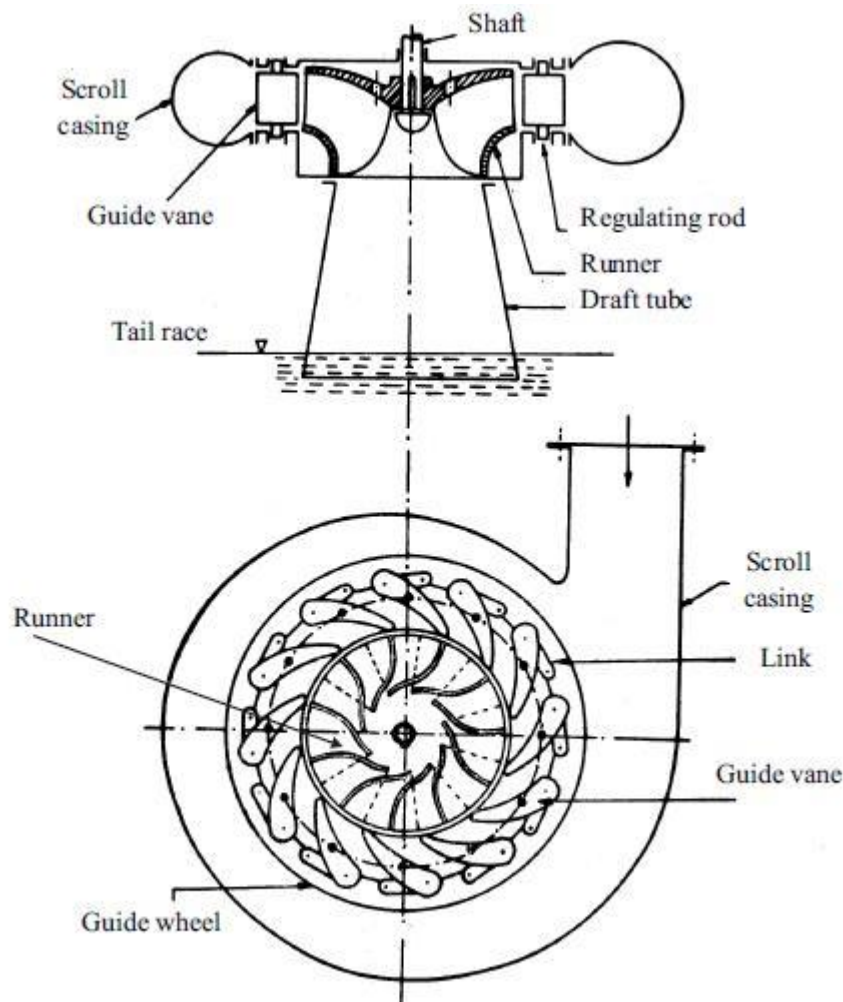

Fig. 4 Francis turbine

Francis turbine which is of mixed flow type is as shown in Fig. 4. It is of inward flow type of turbine in which the water enters the runner radially at the outer periphery and leaves axially at its center.

This turbine consists of: (i) Scrollcasing (ii) Stayingring (iii) Guidevanes (iv) Runner (v) Draft tube.

(i) Scroll Casing: The water from penstock enters the scroll casing (called spiral casing) which completely surrounds the runner. The main function of spiral casing is to provide an uniform distribution of water around the runner and hence to provide constant velocity. In order to provide constant velocity, the cross sectional area of the casing gradually decreases as the water reaching runner

(ii) Stay ring: The water from scroll casing enters the speed vane or stay ring. These are fixed blades and usually half in number of the guide vanes. Their function is to (a)direct the water over the guide vanes, (b) resist the load on turbine due to internal pressure of water and these loads is transmitted to the foundation.

(iii) **Guide Vanes:** Water after the stay ring passes over to the series of guide vanes or fixed vanes. They surrounds completely around the turbine runner. Guide vanes functions are to (a) regulate the quantity of water entering the runner and (b) direct the water on to the runner.

(iv) **Runner:** The main purpose of the other components is to lead the water to the runner with minimum loss of energy. The runner of turbine is consists of series of curved blades (16 to 24) evenly arranged around the circumference in the space between the two plate. The vanes are so shaped that water enters the runner radially at outer periphery and leaves it axially at its center. The change in direction of flow from radial to axial when passes over the runner causes the appreciable change in circumferential force which in turn responsible to develop power.

(v) **Draft Tube:** The water from the runner flows to the tail race through the draft tube. Adraft is a pipe or passage of gradually increasing area which connect the exit of the runner to the tail race. It may be made of cast or plate steel or concrete. The exit end of the draft tube is always submerged below the level of water in the tail race and must be air-tight.

The draft tube has two purposes:

(a) It permits a negative or suction head established at the runner exit, thus making it possible to install the turbine above the tail race level without loss of head.

(b) It converts large proportion of velocity energy rejected from the runner into useful pressure energy

Draft Tubes:

There are different types of draft tubes which are employed to serve the purpose inthe installation of turbine are as shown in Fig.5. It has been observed that for straightdivergent type draft tube, the central cone angle should not be more than 8°. This isbecause, if this angle is more than 8° the water flowing through the draft tube withoutcontacting its inner surface which results in eddies and hence the efficiency of the drafttube is reduced.

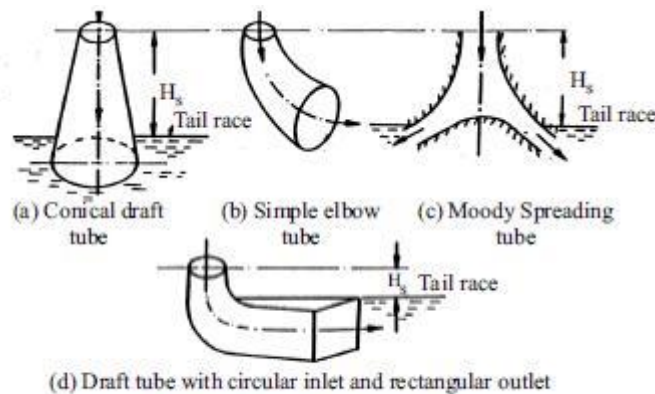

Fig.5. Types of draft tubes

(a) Straight divergent conical tube

(b) Moody spreading tube (or Hydra cone)

(c) Simple elbow tube

(d) Elbow tube having circular cross section at inlet and rectangular cross section at outlet.

Work Done and Efficiencies of Francis Turbine:

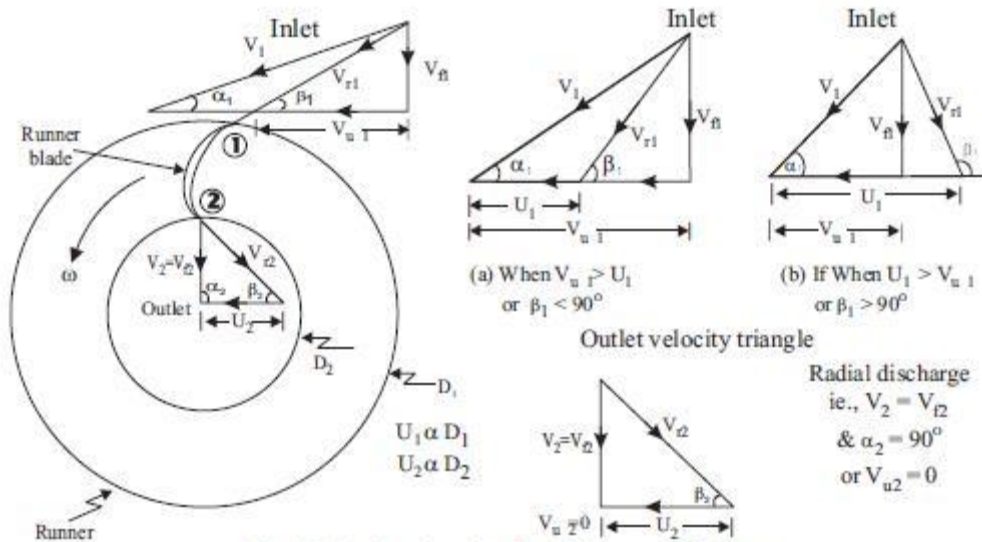

Fig.6 Velocity triangles for different conditions

The absolute velocity at exit leaves the runner such that there is no whirl at exit i.e. $V_{u2} = 0$. The Inlet velocity triangles are drawn for different conditions as shown in Fig 6 (a)&(b).

Propeller & Kaplan Turbines:

The propeller turbine consists of an axial flow runner with 4 to 6 blades of aerofoil shape. The spiral casing and guide blades are similar to that of the Francis turbines. In the propeller turbines, the blades mounted on the runner are fixed and non-adjustable. But in Kaplan turbine the blades can be adjusted and can rotate about the pivots fixed to the boss of the runner. This is only the modification in propeller turbine. The blades are adjusted automatically by a servomechanism so that at all loads the flow enters without shock.

The Kaplan turbine is an axial flow reaction turbine in which the flow is parallel to the axis of the shaft as shown in the Fig. This is mainly used for large quantity of water and for very low heads (4-70 m) for which the specific speed is high. The runner of the Kaplan turbine looks like a propeller of a ship. Therefore sometimes it is also called as propeller turbine. At the exit of the Kaplan turbine the draft tube is connected to discharge water to the tail race.

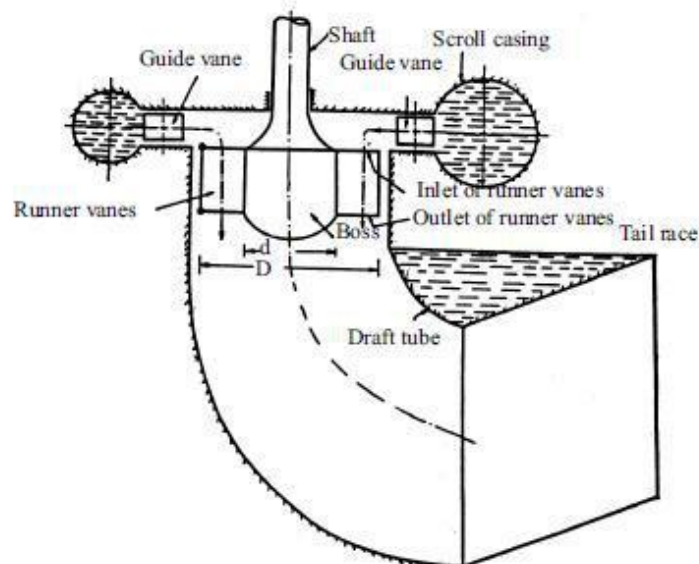

1) At inlet, the velocity V_1 is as shown in below Fig

2) At the outlet, the discharge is always axial with no whirl velocity component i.e., outlet velocity triangle just a right angle triangle as shown below Fig.

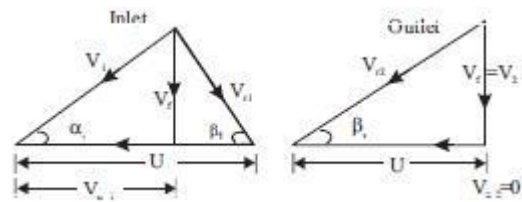

Module -5

CENTRIFUGAL PUMPS

Classification and parts of centrifugal pump:

Rotodynamic Pumps

A rotodynamic pump is a device where mechanical energy is transferred from the rotor to the fluid by the principle of fluid motion through it. The energy of the fluid can be sensed from the pressure and velocity of the fluid at the delivery end of the pump. Therefore, it is essentially a turbine in reverse. Like turbines, pumps are classified according to the main direction of fluid path through them like (i) radial flow or centrifugal, (ii) axial flow and (iii) mixed flow types.

Centrifugal Pumps

The pumps employing centrifugal effects for increasing fluid pressure have been in use for more than a century. The centrifugal pump, by its principle, is converse of the Francis turbine. The flow is radically outward, and hence the fluid gains in centrifugal head while flowing through it. Because of certain inherent advantages, such as compactness, smooth and uniform flow, low initial cost and high efficiency even at low heads, centrifugal pumps are used in almost all pumping systems. However, before considering the operation of a pump in detail, a general pumping system is discussed as follows.

Different heads and efficiencies of centrifugal pump:

The word pumping, referred to a hydraulic system commonly implies to convey liquid from a low to a high reservoir. Such a pumping system, in general, is shown in Fig. 33.1. At any point in the system, the elevation or potential head is measured from a fixed reference datum line. The total head at any point comprises pressure head, velocity head and elevation

head. For the lower reservoir, the total head at the free surface is H_A and is equal to the elevation of the free surface above the datum line since the velocity and static pressure

at A are zero. Similarly the total head at the free surface in the higher reservoir is $(H_A + H_S)$ and is equal to the elevation of the free surface of the reservoir above the reference datum.

The variation of total head as the liquid flows through the system is shown in Fig. 33.2. The

liquid enters the intake pipe causing a head loss for which the total energy line drops to point B corresponding to a location just after the entrance to intake pipe. The total head at B can be written as

$$H_B = H_A - h_m$$

As the fluid flows from the intake to the inlet flange of the pump at elevation z_1 the total head drops further to the point C (Figure 33.2) due to pipe friction and other losses equivalent

to h_{f1} . The fluid then enters the pump and gains energy imparted by the moving rotor of the pump. This raises the total head of the fluid to a point D (Figure 33.2) at the pump outlet (Figure 33.1).

In course of flow from the pump outlet to the upper reservoir, friction and other losses

account for a total head loss or h_{f2} down to a point E . At E an exit loss h_e occurs when the liquid enters the upper reservoir, bringing the total head at point F (Figure 33.2) to that at the free surface of the upper reservoir. If the total heads are measured at the inlet and outlet flanges respectively, as done in a standard pump test, then

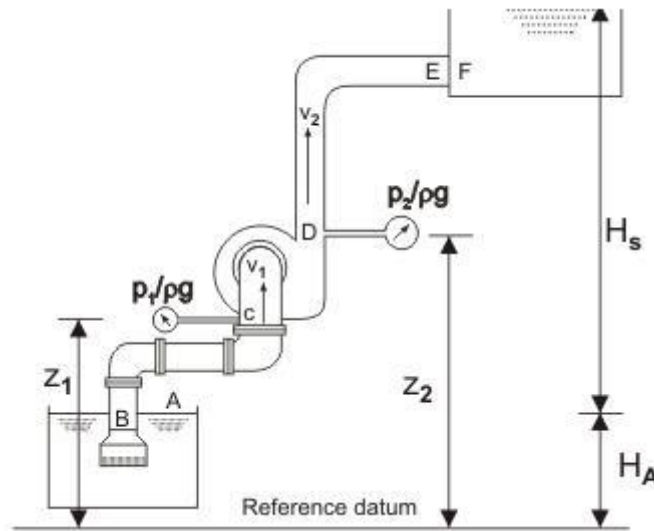

Fig. A general pumping system

Change of head in a pumping system

$$\text{Total inlet head to the pump} = \frac{p_1}{\rho g} + \frac{V_1^2}{2g} + z_1$$

$$\text{Total outlet head of the pump} = \frac{p_2}{\rho g} + \frac{V_2^2}{2g} + z_2$$

where V_1 and V_2 are the velocities in suction and delivery pipes respectively.

Therefore, the total head developed by the pump,

$$H = \left[\frac{p_2 - p_1}{\rho g} \right] + \left[\frac{V_2^2 - V_1^2}{2g} \right] + [z_2 - z_1] \quad (33.1)$$

The head developed H is termed as *manometric head*. If the pipes connected to inlet and

outlet of the pump are of same diameter, $V_2 = V_1$ and therefore the head developed or manometric head H is simply the gain in piezometric pressure head across the pump which could have been recorded by a manometer connected between the inlet and outlet flanges of

the pump. In practice, $(z_2 - z_1)$ is so small in comparison to $\frac{p_2 - p_1}{\rho g}$ that it is ignored. It is therefore not surprising to find that the static pressure head across the pump is often used to describe the total head developed by the pump. The vertical distance between the two

levels in the reservoirs H_s is known as static head or static lift. Relationship between H_s , the static head and H , the head developed can be found out by applying Bernoulli's equation between A and C and between D and F (Figure 33.1) as follows:

$$0 + 0 + H_A = \frac{p_1}{\rho g} + \frac{V_1^2}{2g} + z_1 + h_{in} + h_{f1}$$

Between D and F ,

$$\frac{p_2}{\rho g} + \frac{V_2^2}{2g} + z_2 = 0 + 0 + H_s + H_A + h_{f2} + h_e$$

substituting H_A from Eq. (33.2) into Eq. (33.3), and then with the help of Eq. (33.1),

we can write

$$\begin{aligned} H &= H_s + h_{in} + h_{f1} + h_{f2} + h_e \\ &= H_s + \sum \text{losses} \end{aligned}$$

Therefore, we have, the total head developed by the pump = static head + sum of all the losses.

The simplest form of a centrifugal pump is shown in Figure. It consists of three important parts: (i) the rotor, usually called as impeller, (ii) the volute casing and (iii) the diffuser ring. The impeller is a rotating solid disc with curved blades standing out vertically from the face of the disc. The impeller may be single sided double sided A double sided impeller has a relatively small flow capacity.

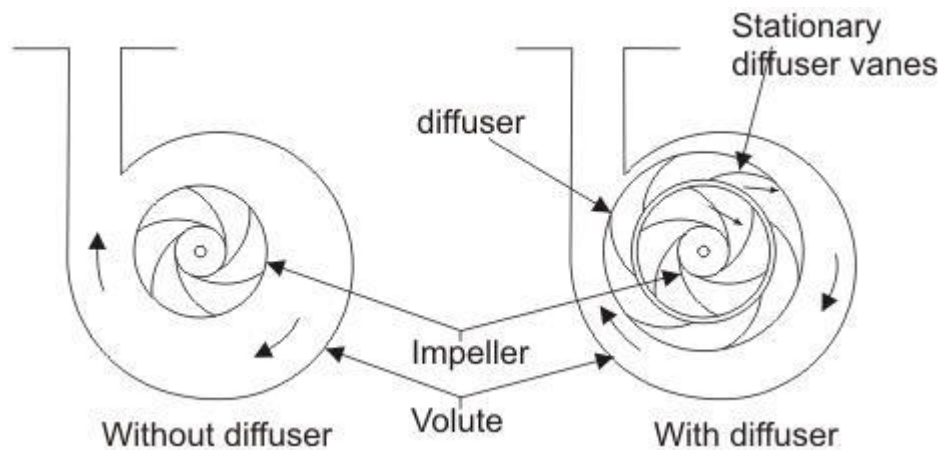

centrifugal pump

The tips of the blades are sometimes covered by another flat disc to give shrouded blades otherwise the blade tips are left open and the casing of the pump itself forms the solid outer

wall of the blade passages. The advantage of the shrouded blade is that flow is prevented from leaking across the blade tips from one passage to another

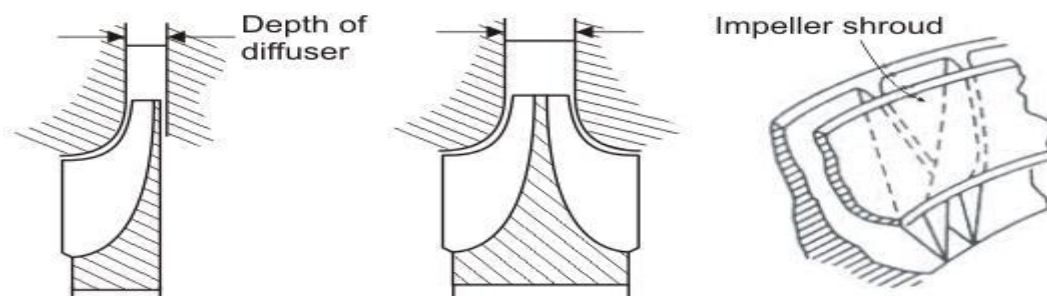

(a) Single sided impeller (b) Double sided impeller (c) Shrouded impeller Figure 33.4
Types of impellers in a centrifugal pump

As the impeller rotates, the fluid is drawn into the blade passage at the impeller eye, the centre of the impeller. The inlet pipe is axial and therefore fluid enters the impeller with very little whirl or tangential component of velocity and flows outwards in the direction of the blades. The fluid receives energy from the impeller while flowing through it and is discharged with increased pressure and velocity into the casing. To convert the kinetic energy of fluid at the impeller outlet gradually into pressure energy, diffuser blades mounted on a diffuser ring are used.

The stationary blade passages so formed have an increasing cross-sectional area which reduces the flow velocity and hence increases the static pressure of the fluid. Finally, the fluid moves from the diffuser blades into the volute casing which is a passage of gradually increasing cross-section and also serves to reduce the velocity of fluid and to convert some of the velocity head into static head. Sometimes pumps have only volute casing without any diffuser.

Figure shows an impeller of a centrifugal pump with the velocity triangles drawn at inlet and outlet. The blades are curved between the inlet and outlet radius. A particle of fluid moves along the broken curve shown in Figure

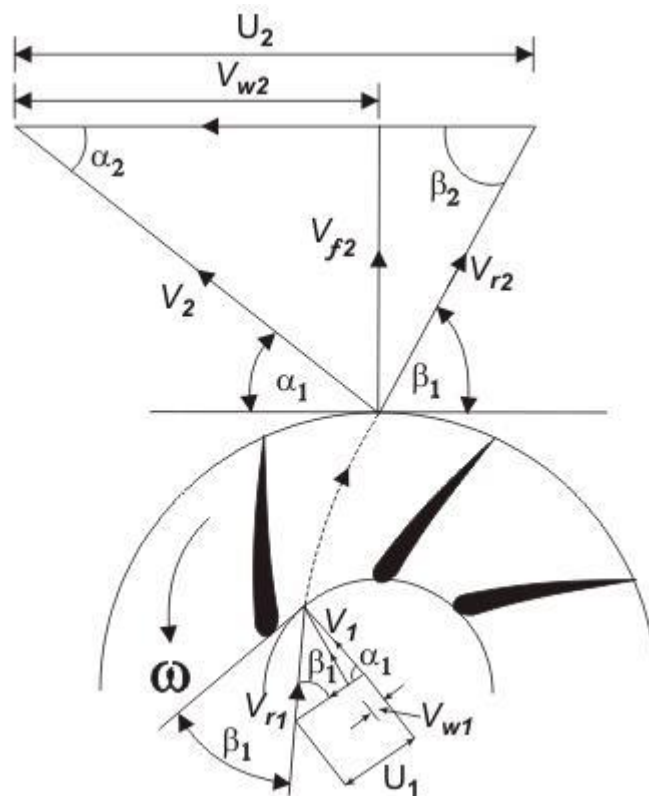

Velocity triangles for centrifugal pump Impeller

Let α_1 be the angle made by the blade at inlet, with the tangent to the inlet radius, while β_1

is the blade angle with the tangent at outlet. V_1 and V_2 are the absolute velocities of fluid at

inlet an outlet respectively, while V_{r1} and V_{r2} are the relative velocities (with respect to blade velocity) at inlet and outlet respectively. Therefore,

$$\text{Work done on the fluid per unit weight} = (V_{w2}U_2 - V_{w1}U_1) / g$$

A centrifugal pump rarely has any sort of guide vanes at inlet. The fluid therefore approaches the impeller without appreciable whirl and so the inlet angle of the blades is designed to produce a right-angled velocity triangle at inlet (as shown in Fig. 34.1). At conditions other

than those for which the impeller was designed, the direction of relative velocity V_r does not coincide with that of a blade. Consequently, the fluid changes direction abruptly on entering the impeller. In addition, the eddies give rise to some back flow into the inlet pipe, thus causing fluid to have some whirl before entering the impeller. However, considering the

operation under design conditions, the inlet whirl velocity V_{w1} and accordingly the inlet

angular momentum of the fluid entering the impeller is set to zero. Therefore, Eq. (34.1) can be written as

$$\text{Work done on the fluid per unit weight} = V_{w2}U_2 / g$$

We see from this equation that the work done is independent of the inlet radius. The difference in total head across the pump known as manometric head, is always less than the

quantity $V_{w2}U_2 / g$ because of the energy dissipated in eddies due to friction.

The ratio of manometric head H and the work head imparted by the rotor on the fluid $V_{w2}U_2 / g$ (usually known as Euler head) is termed as manometric efficiency η_m . It represents the effectiveness of the pump in increasing the total energy of the fluid from the energy given to it by the impeller. Therefore, we can write

$$\eta_m = \frac{gH}{V_{w2}U_2}$$

The overall efficiency η_0 of a pump is defined as

$$\eta_0 = \frac{\rho Q g H}{P}$$

where, Q is the volume flow rate of the fluid through the pump, and P is the shaft power, i.e.

the input power to the shaft. The energy required at the shaft exceeds $V_{w2}U_2 / g$ because of friction in the bearings and other mechanical parts. Thus a mechanical efficiency is defined as

$$\eta_{\text{mech}} = \frac{\rho Q V_{w2} U_2}{P}$$

So that

$$\eta_0 = \eta_m \times \eta_{\text{mech}}$$

Cavitation

If the pressure at any point in a suction side of centrifugal pump falls below the vapor pressure, then the water starts boiling forming saturated vapor bubbles. Thus, formed bubbles moves at very high velocity to the more pressure side of the impeller blade, and strikes the surface of the blade and collapse there. In this way, as the pressure still further decreases, more bubbles will be formed and collapses on the surface of the blade, physically enables to erosion and pitting, forming a cavities on blades. This process takes place many thousand times in a second and damages the blade of a centrifugal pump. This phenomenon is known as **Cavitation**.

Net Positive Suction Head (NPSH)

Net Positive Suction Head (NPSH) is the head required at the pump inlet to keep the water from cavitating or boiling. The cavitation is likely to occur on suction side of the pump as the lowest pressure can exist in this region. The NPSH is defined as,

$$\text{NPSH} = \frac{p_s}{\rho g} + \frac{V_s^2}{2g} - \frac{p_{\text{vap}}}{\rho g}$$

Where V_s is the velocity of the water in suction side, p_s and p_{vap} are the pressure at the inlet and the vapour pressure in absolute units. NPSH indicates the height of the pump axis from the water surface in the sump to which it can be installed to avoid cavitation problem.

Cavitation Factor or Thoma's Cavitation Factor (σ)

The cavitation factor (σ) is defined as the ratio of total inlet head above the vapour pressure at the suction side of the pump to the head developed by the pump.

$$\sigma = \frac{\text{Total head above the vapour pressure at the pump inlet}}{\text{Head developed by the pump}}$$

$$\text{Therefore, } \sigma = \frac{(p_s/\rho g) + (V_s^2/2g) - p_{\text{vap}}/\rho g}{H_m} = \frac{\text{NPSH}}{H_m}$$

By applying the Bernoulli's equation between the free surface of the water in the sump and the pump inlet, the eqn.(9.17) can also be written as,

$$\sigma = \frac{H_{\text{atm}} - H_{\text{vap}} - H_{\text{suct}}}{H_m}$$

Where H_{atm} is the atmospheric pressure head in m, H_{vap} is the vapour pressure head in m, H_{suct} is the sum of frictional loss for the suction pipe length (h_{fs}) and elevation of centre line of pump (h_s) from sump water free surface.

The cavitation factor (σ) is constant in all geometrically similar pumps under similar flow conditions. If the cavitation factor (σ) calculated using eqn. (8.18) is greater than the critical cavitation factor (σ_c), then the cavitation will not occur. In order to obtain higher value of σ it is preferred to adopt lesser h_s or lesser h_{fs} . The use of σ not only indicates cavitation inception but also denotes the stage of cavitation occurring in the machine. Generally the value of σ should be more than 0.04 in order to avoid cavitation otherwise, cavitation occurs.

Precautions for Preventing the Cavitation

The following steps should be taken into account to prevent the cavitation:

- (i) the pressure of the fluid flow in any part of the system should not fall below the vapour pressure. If the water is the working fluid, the absolute pressure head should not be below 2.5 m of water.
- (ii) the impeller should be made of better cavitation resistant materials such as aluminium, bronze and stainless steel

Cavitation Effect

The following are the effects of cavitation:

- (i) the metallic surfaces damage and cavities are formed on the impeller surface.
 - (ii) considerable noise and vibration are produced due to the sudden collapse of vapour bubble.
-

Need for priming

The action taken to stimulate an economy, usually during a recessionary period, through government spending, and interest rate and tax reductions. The term "pump priming" is derived from the operation of older pumps; a suction valve had to be primed with water so that the pump would function properly. As with these pumps, pump priming assumes that the economy must be primed to function properly once again. In this regard, government spending is assumed to stimulate private spending, which in turn should lead to economic expansion.

Slip Factor

Under certain circumstances, the angle at which the fluid leaves the impeller may not be the same as the actual blade angle. This is due to a phenomenon known as fluid slip, which

finally results in a reduction in V_{w2} the tangential component of fluid velocity at impeller outlet. One possible explanation for slip is given as follows.

In course of flow through the impeller passage, there occurs a difference in pressure and velocity between the leading and trailing faces of the impeller blades. On the leading face of a blade there is relatively a high pressure and low velocity, while on the trailing face, the pressure is lower and hence the velocity is higher. This results in a circulation around the blade and a non-uniform velocity distribution at any radius. The mean direction of flow at

outlet, under this situation, changes from the blade angle at outlet β_2 to a different angle β_2'

as shown in Figure 34.2 Therefore the tangential velocity component at outlet V_{w2} is

reduced to V_{w2}' , as shown by the velocity triangles in Figure 34.2, and the difference ΔV_w is

defined as the slip. The slip factor σ_s is defined as

CENTRIFUGAL COMPRESSORS

Introduction

Power absorbing Turbo machines used to handle compressible fluids like air, gases etc, can be broadly classified into: (i) Fans (ii) Blowers and (iii) Compressors. These machines produce the head (pressure) in the expense of mechanical energy input. The pressure rise in centrifugal type machines are purely due to the centrifugal effects.

A fan usually consists of a single rotor with or without a stator. It causes only a small pressure rise as low as a few centimeters of water column. Generally it raises the pressure up to a maximum of 0.07 bar (70 cm WG). In the analysis of the fan, the fluid will be treated as incompressible as the density change is very small due to small pressure rise. Fans are used for air circulation in buildings, for ventilation, in automobiles in front of engine for cooling purposes etc.

Blower may consist of one or more stages of compression with its rotors mounted on a common shaft. The air is compressed in a series of successive stages and is passed through a diffuser located near the exit to recover the pressure energy from the large kinetic energy. The overall pressure rise may be in the range of 1.5 to 2.5 bars. Blowers are used in ventilation, power station, workshops etc.

Compressor is used to produce large pressure rise ranging from 2.5 to 10 bar or more. A single stage compressor can generally produce a pressure rise up to 4 bars. Since the velocities of air flow are quite high, the Mach number and compressibility effects may have to be taken into account in evaluating the stage performance of a compressor.

In general the centrifugal compressor may be known as a fan, blower, supercharger etc, depending on the need to be served. Broadly speaking, fans are the low-pressure compressors; blowers are the medium pressure compressors. It is therefore the analysis of one, say centrifugal compressor, will also hold good to the other machines like blower, fans.

Important Elements of a Centrifugal Compressor

Fig. shows the essential parts of a typical centrifugal compressor. It mainly consists of

(i) Inlet casing with the converging nozzle (ii) the impeller (iii) the diffuser and (iv) The outlet casing.

The function of the inlet casing with the convergent nozzle is to accelerate the entering fluid to the impeller inlet. The inlet nozzle accelerates the fluid from the initial condition (state 0) to the entry of the Inlet Guide Vanes (IGV) which direct the flow in the desired direction at the inlet of the impeller (state 1).

The impeller convert the supplied mechanical energy into fluid energy whereby the fluidkinetic energy and the static pressure rises. An impeller is made of radial blades which are brazed to the shroud. It can be made from a single piece consisting of both the inducer and a

Largely radial portion. The inducer receives the flow between the hub and tip diameters (dh and dt) of the impeller eye and passes on to the radial portion of the impeller blades. The flow approaching the impeller may be with or without swirl. The inlet diameter 4.2 Important

Elements of a Centrifugal Compressor Fig. show the essential parts of a typical centrifugal compressor. It mainly consists of (i) inlet casing with the converging nozzle (ii) the impeller (iii) the diffuser and (iv) the outlet casing.

The function of the inlet casing with the convergent nozzle is to accelerate the entering fluid to the impeller inlet. The inlet nozzle accelerates the fluid from the initial condition (state 0) to the entry of the Inlet Guide Vanes (IGV) which direct the flow in the desired direction at the inlet of the impeller (state 1).

The impeller convert the supplied mechanical energy into fluid energy whereby the fluidkinetic energy and the static pressure rises. An impeller is made of radial blades which are brazed to the shroud. It can be made from a single piece consisting of both the inducer and a largely radial portion. The inducer receives the flow between the hub and tip diameters (dh and dt) of the impeller eye and passes on to the radial portion of the impeller blades. The flow approaching the impeller may be with or without swirl.

Stage velocity triangles

Velocity Triangles at the Eye Hub and Tip

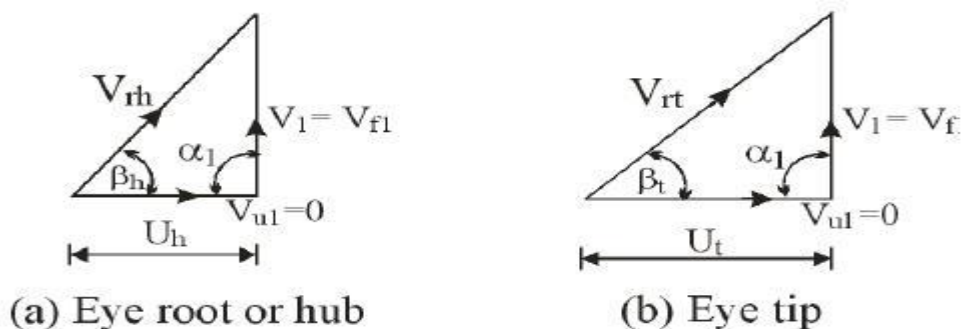

In an ideal condition the fluid enters the eye section radially with no whirl component. The velocity of flow remains constant from hub to tip of the eye. The tangential velocities of the impeller at the hub (root) and the tip of the eye are calculated based on the corresponding hub

and tip diameters of the eye respectively as shows in above figure the inlet velocity triangles at the hub

and tip of the eye. The relative blade angle at the hub β_h is slightly larger than that at the tip as shown in Figure.

$$U_h = \frac{\pi d_b N}{60}$$

Tangential velocity of the impeller at the eye tip is

$$U_t = \frac{\pi d_t N}{60}$$

The mass flow rate of the air entering the impeller eye can be calculated as

$$\dot{m} = \pi/4 (d_t^2 - d_b^2) V_{f1} \rho_1$$

Slip and Slip Co-efficient

In deriving the Euler's equation, it was assumed that the velocities are constant (uniform) over the cross sectional area. But in actual practice this assumption is not correct because the velocities are not constant over a cross sectional area as shown in Fig.

Due to uneven pressure distribution and hence the velocity distribution, head developed by the machine is always less than that developed at the ideal condition. The energy transfer (work) to the shaft is therefore simply reduced by a certain amount due to slip.

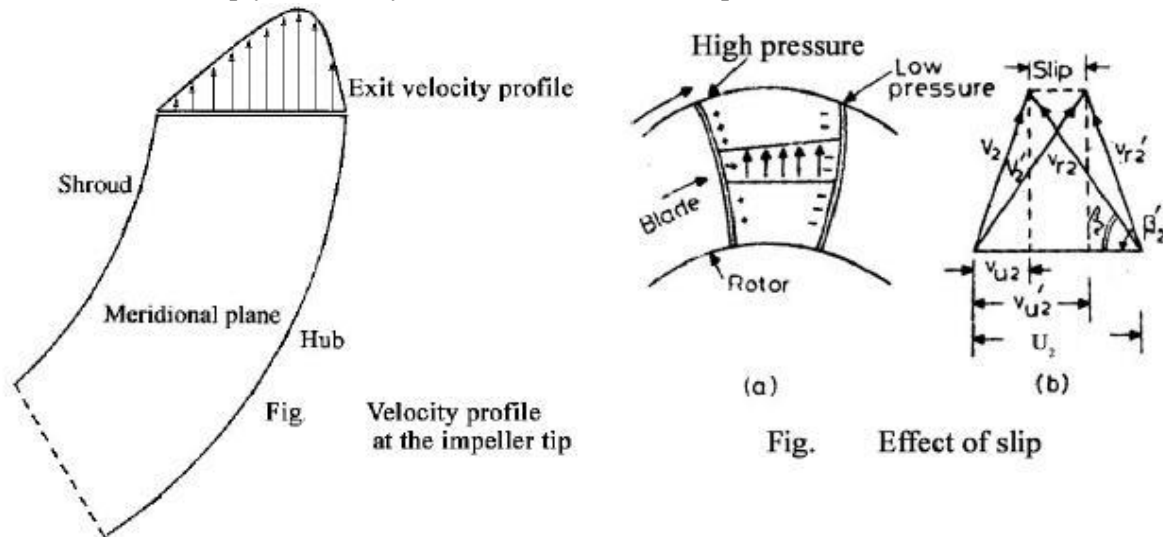

In above Fig, the component drawn with dash referred to the ideal conditions without slip and without dash refers to an ideal condition after considering the slip and non-uniform velocity distribution at the tip. The head based on the ideal velocity diagrams without slip is called Euler's head (H_e) and the head obtained corresponding to the slip is called ideal head

(H_i) as the fluid is ideal. The actual head developed by the machine is related to the ideal head through the adiabatic or diagram efficiency (η) of a machine. The difference between the Euler's head (H_e) and the ideal head (H_i) is called the slip. It can also be defined as the difference between tangential component of the velocity V_{u2} and V'_{u2} . Therefore Slip, $S = V'_{u2} - V_{u2}$. The ratio of ideal head with the slip to the Euler's head without slip is called the slip coefficient. Therefore the slip coefficient is given by

$$\mu = H_i / H_e = V_{u2} / V'_{u2}$$

The slip factor is a parameter which limits the work capacity of the compressor even under ideal conditions and this quantity should be as high as possible. More the number of vanes, Greater will be the value of slip factor, but increases the solidity of the impeller eye, i.e., a decrease in the effective flow area. This gives an additional frictional loss at the eye which is not recommended. It is therefore necessary to select the number of vanes in the impeller so as to give minimum losses. Generally, in practice, 19-20 vanes will be selected so that the slip factor value is around 0.9.

Surging

The phenomenon of momentary fluctuations in head and discharge due to unsteady flow, Flow reversal and vibration at low flow rates is called "Surging".

Let us consider that the compressor is operating at the state C as shown in Fig.4.16. If the flow is reduced by gradual closing of the delivery valve, the operating point now shifted to stable equilibrium point B. On further decrease in flow the operating point shifts to the left side of the curve, eventually reaches the maximum pressure ratio point A. Any further decrease in flow will not increase the pressure ratio and hence starts reducing. At this condition there is a large pressure in the downstream of the system near exit than at compressor delivery and the flow stops momentarily, and may even flow in the reverse direction. This reduces the downstream pressure. After short interval of time, the compressor again starts to deliver the air and the operating point quickly shifts to C again. Again the

pressure starts increasing and the operating point moves from right to left. If the downstream conditions are remain unchanged then once again the flow will breakdown after point A and the cycle will be repeated with a high frequency. This phenomenon is called 'surging' or 'pumping'.

If the surging is severe enough then the compressor may be ultimately subjected to impact loads and high frequency vibration leads to the physical damage due to the producing of high pressures repeatedly. Because of this phenomenon at the low flow rates, the compressor cannot operate on the positive slope of the curve, i.e., to the left portion of the point A.

At higher mass flow rates the behavior of the compressor will be different. If the mass flow rates are higher the characteristic curve will be along ABCD as shown in Fig.4.16. It can be seen from Fig. that for the increased mass flow rate the pressure ratio start decreasing and hence the density also. This effect causes the increase of absolute velocity and angle of incidence at the diffuser vane top. This leads to the rapid steepening in the slope of the curve and finally reaches a point D, beyond which there will be no further increase in mass flow rate for any value of pressure ratio. Therefore the characteristic curve at this point becomes vertical and the point D on the curve is called Choking point.

Choking is therefore defined as the phenomenon in which the mass flow rate reaches to a fixed value irrespective of any of pressure ratios. Choking means the velocity of fluid in the passage reaches the velocity of sound at that point within the compressor. Choking may occur anywhere within the machine such as at the inlet, in the impeller or in the diffuser section.

Axial flow Compressors

The basic components of an axial flow compressor are a rotor and stator, the former carrying the moving blades and the latter the stationary rows of blades. The stationary blades convert the kinetic energy of the fluid into pressure energy, and also redirect the flow into an angle suitable for entry to the next row of moving blades. Each stage will consist of one rotor row followed by a stator row, but it is usual to provide a row of so called inlet guide vanes. This is an additional stator row upstream of the first stage in the compressor and serves to direct the axially approaching flow correctly into the first row of rotating blades. For a compressor, a row of rotor blades followed by a row of stator blades is called a stage. Two forms of rotor have been taken up, namely drum type and disk type. A disk type rotor illustrated in Figure 9.1 The disk type is used where consideration of low weight is most important. There is a contraction of the flow annulus from the low to the high pressure end of the compressor. This is necessary to maintain the axial velocity at a reasonably constant level throughout the length of the compressor despite the increase in density of air. Figure 9.2 illustrate flow through compressor stages. In an axial compressor, the flow rate tends to be high and pressure rise per stage is low. It also maintains fairly high efficiency

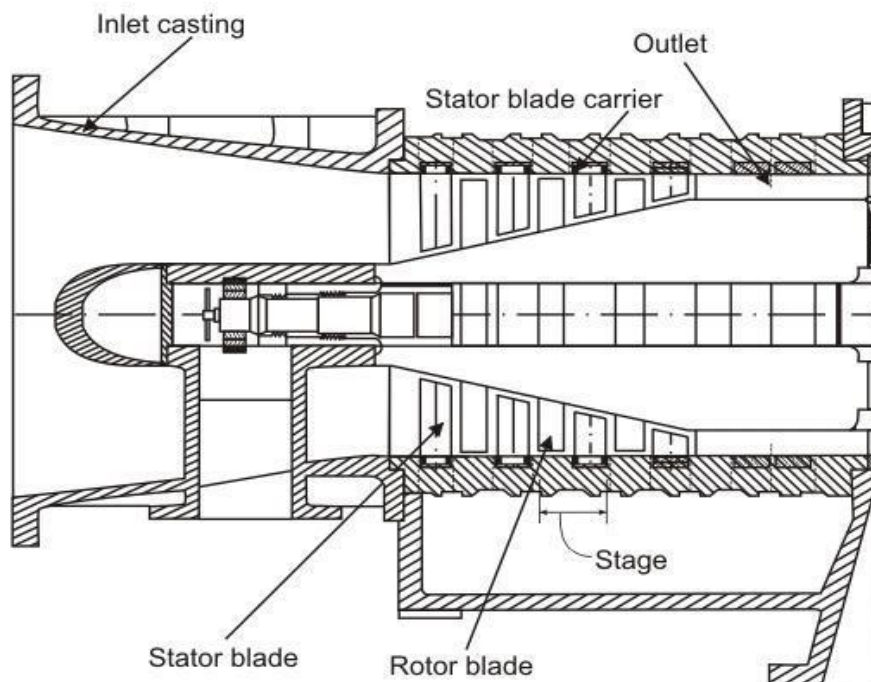

Disk type axial flow compressor

The basic principle of acceleration of the working fluid, followed by diffusion to convert acquired kinetic energy into a pressure rise, is applied in the axial compressor. The flow is considered as occurring in a tangential plane at the mean blade height where the blade peripheral velocity is U . This two dimensional approach means that in general the flow velocity will have two components, one axial and one peripheral denoted by subscript w , implying a whirl velocity. It is first assumed that the air approaches the rotor blades with an

absolute velocity, V_1 , at an angle α_1 to the axial direction. In combination with the peripheral

velocity U of the blades, its relative velocity will be V_{r1} at an angle β_1 as shown in the upper velocity triangle (Figure 9.3). After passing through the diverging passages formed between the rotor blades which do work on the air and increase its absolute velocity, the air

will emerge with the relative velocity of V_{r2} at angle β_2 which is less than β_1 . This turning of air towards the axial direction is, as previously mentioned, necessary to provide an increase in the effective flow area and is brought about by the camber of the blades.

Since V_{r2} is less than V_{r1} due to diffusion, some pressure rise has been accomplished in the

from the rotor at an angle α_2 to the axial direction. The air then passes through the passages

formed by the stator blades where it is further diffused to velocity V_3 at an angle α_3 which

in most designs equals to α_1 so that it is prepared for entry to next stage. Here again, the turning of the air towards the axial direction is brought about by the camber of the blades.

Overall Pressure ratio (pro)

Actual energy transfer or
work done on the air per unit mass is

$$E = h_{02} - h_{01} = \Psi \mu U_2^2 / g_c$$

As there is no work transfer in the diffuser,
by energy balance we can write,

$$h_{03} - h_{01} = h_{02} - h_{01}$$

Therefore eqn (4.18) for the ideal gas can be written as

$$C_p (T_{03} - T_{01}) = \Psi \mu U_2^2 / g_c$$

$$\Rightarrow (T_{03} - T_{01}) = \Psi \mu U_2^2 / C_p$$

The overall total-to-total efficiency of the compressor is defined as

$$\eta_{t-t} = \frac{\text{Total isentropic enthalpy rise between the inlet and exit}}{\text{Actual enthalpy rise between the same inlet and exit}}$$

$$\eta_{t-t} = \frac{C_p (T_{03}' - T_{01})}{C_p (T_{03} - T_{01})}$$

Using isentropic relation and with the use of equations (1) and (2) is written for the overall pressure ratio as

$$\frac{T_{03}'}{T_{01}} = \frac{p_{03}}{p_{01}} = \left[1 + \frac{\eta_{t-t} \Psi \mu U_2^2}{C_p T_{01}} \right]^{\frac{\gamma}{\gamma-1}}$$