

Hydroelectric Power plants

* Hydrology : It can be defined as the science that deals with the processes governing depletion and replenishment of water resources over and within the surface of earth.

* Run-off : It is the portion of precipitation which makes its way towards streams, lakes or oceans. Run-off can be possible only when the rate precipitation exceeds the rate at which water infiltrates into the soil and after small and large depressions on the soil surface get filled up with water. Also losses due to evaporation have to be deducted. In general, the run-off is given by $R = P - E$ where $R =$ Run off, $P =$ Precipitation, $E =$ Evaporation.

* Stream flow : It is the volume of water that moves through a specific point in a stream during a given period of time. It is also the flow of water in streams, rivers and other channels, and is a major element of the water cycle.

* Hydrograph : It is the plot between discharges versus time of the flow. Hydrograph is shown in figure 1 below.

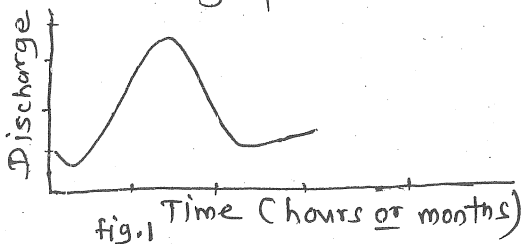

Discharge is plotted on Y-axis and the corresponding time that may be months, hours etc. is plotted on the X-axis. Hydrograph also indicates the available power from the streams at different times.

* Flow duration Curve : It is a plot of discharge versus percentage of time for which the discharge is available. It is obtained from the hydrograph data. The flow or discharge can be expressed as cubic meters per second, per week or other unit of time. The flow duration curve becomes the load duration curve for hydroelectric plant and thus it is possible to know the total power available at the site. The maximum and minimum conditions of the flow can also be obtained by the flow duration curve where minimum flow condition decides the maximum capacity of plant that can be improved by increasing the storage capacity. fig.2. shows the flow duration curve.

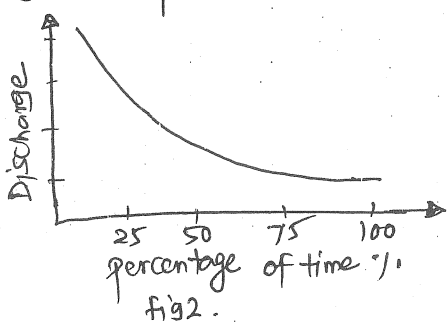

fig.2. shows the flow duration curve.

* Mass Curve & Reservoir Capacity :

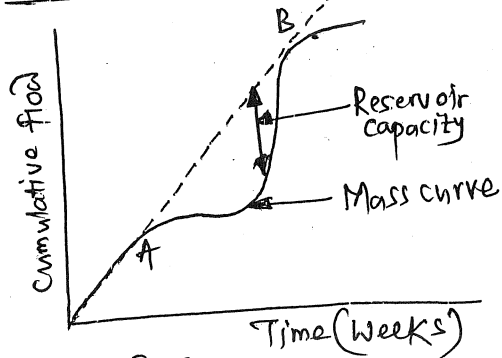

fig 3.

It is a plot of cumulative volume of water that can be stored from a stream flow versus time in days, weeks or months. Fig 3 shows a mass curve. Maximum intercept between line AB and mass curve is known as reservoir capacity.

The capacity of reservoir, made for a period of deficiency to make available the flow of water at a required rate is studied by mass curve.

* Dam Storage : The function of dam is to provide a head of water to be utilised in the water turbine. Though many times high dams may be built solely to provide the necessary head to the plant, dam also increases the reservoir capacity. Demand peaks or (short) periods of water shortage can be bridged by Dams as they can buffer water.

* Hydrological cycle : The cyclic movement called hydrologic cycle of water rotates water from the sea to the atmosphere by evaporation, and then from there by precipitation to earth and finally through streams, rivers, etc. back to the sea.

* Merits and demerits of hydroelectric power plants :

Merits :

- i) It requires no fuel, as water is used for the generation of electrical energy
- ii) It is quite neat and clean as no smoke or ash is produced
- iii) It requires very small running charges because water is the source of energy which is available free of cost
- iv) It is comparatively simple in construction & requires less maintenance.
- v) It does not require a long starting time like a steam power station. In fact, such plants can be put into service instantly.
- vi) It is robust and has longer life.
- vii) Such plants serve many purposes. In addition to the generation of electrical energy, they also help in irrigation and controlling floods.
- viii) Although such plants require the attention of highly skilled person at the time of construction, yet for operation, a few experienced persons may do the job well.

Demerits :

- i) It involves high capital cost due to construction of dam.
- ii) There is uncertainty about the availability of huge amount of water due to dependence on weather conditions.
- iii) Skilled and experienced hands are required to build the plant.
- iv) It requires high cost of transmission lines as the plant is located in hilly areas which are quite away from the consumers.

* Selection of site :

Selection of hydroelectric plants location depends on the following several factors.

- i) Availability of water : Water energy can be available in the form of either potential energy or kinetic energy. To extract the potential energy, a reservoir or pondage is required whereas to extract the ^{potential} kinetic energy, run-off-river project is used. In all the cases, a huge amount of water is required. Normally water is collected in reservoirs during the rain and used for the electricity production throughout the year. Hilly areas are most suitable for hydropower plants.
- ii) Storage of water : When the kinetic energy of water is low it is preferable to have the reservoirs to collect the water for use of electricity production. Due to wide variation of rainfall during the year makes it necessary to have the reservoirs. The storage capacity of water is calculated by mass curve. The capacity of plants is based on the water energy available taking into the account of losses due to evaporation & percolation.
- iii) Head of water : The availability of head depends upon the topography of the area. High head means high potential energy. To get most economical and effective head, it is necessary to consider all possible factors, which affect it.
- iv) Accessibility of site : The site should be easily accessed by rail or road for transporting the plant equipments etc.
- v) Distance from power station to the load centres : The generating stations are normally connected to the main grid through the transmission lines. The cost of transmission lines are also considered during the selection of site.
- vi) Availability of land : The land should be available at reasonable price, for economical production of electricity.
- vii) Type of land : Bearing capacity of the ground should be adequate to withstand the weight of heavy equipment to be installed.

* General arrangement of hydel plant : shows in figure 4 below.

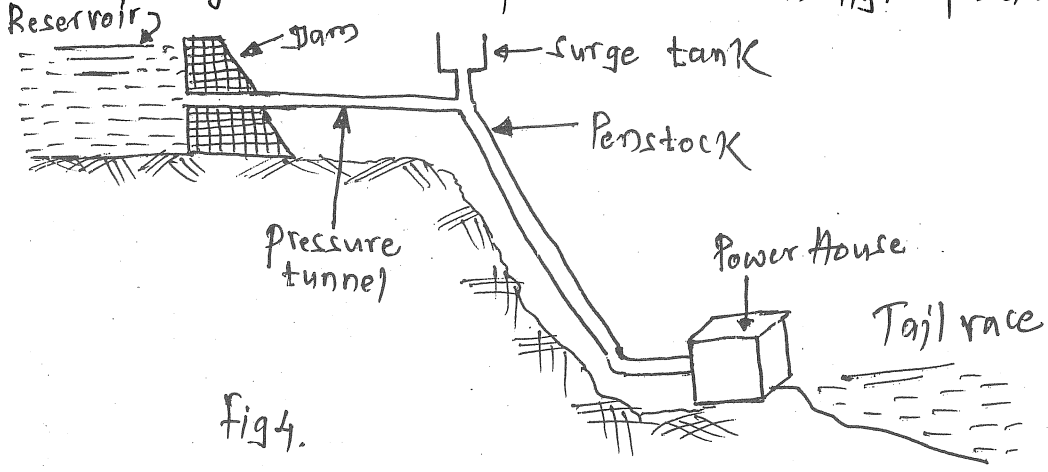

Fig 4.

* Elements of the plant :

The main elements of a typical hydroelectric plant are : dam, reservoir, water conduit system, tailrace, surge tank, trash rack, & powerhouse (which consists of generator, prime mover, switchyard etc)

i) Dam or barrage : A dam or barrage is constructed to provide a head of water to be utilized in the water turbines. A dam across the river is a very important component in most of the high- and medium head hydropower plants. Dams are also built on top of hills, in case of pump storage power plants, where is no inflow.

ii) Reservoir and forebay : The main purpose of reservoir is to store water which may be used to generate electricity and for irrigation purposes. The water is mainly stored during the rainy season. The capacity of the reservoir is decided by the water requirement for power generation.

forebay is a regulating reservoir storing water temporarily when the load on turbine is reduced and provide water when load is increased. It can be considered as the surge reservoir near the intake. This may be the pond behind the diversion dam or canal spread out.

iii) Water Conduit system : A water conduit system carries water from the reservoir to the turbine of powerhouse through the pressure tunnel or pipes called penstocks those may be laid above ground or underground.

iv) Tailrace : water is discharged into the tailrace after passing through the turbine, which carries it into the river. A tailrace is an open channel or tunnel depending upon the powerhouse location. A discharge from all the turbines is collected in the tailrace at its beginning by means of branch channels. The tailrace may discharge into the original river itself or some other river.

v) Surge tank : It is provided to act as pressure release valve of the water conduit system from the effect of water hammer, which is the sudden change of water pressure above the normal. When an additional storage space (called surge tank), near turbine is provided which stores water during the turbine load reduction and release water when sudden increase in load is required, it controls the pressure variation of penstock and prevents water hammer effect. Water hammering is takes place in the penstock when the abnormal surges are created in the penstock. Water hammering may affects on the penstocks in terms of bursting.

Different types of surge tanks being used namely, simple type, restricted orifice type, differential type, expansion chamber type and overflow type.

vi) Trash rack : It is provided to stop the entry of debris, which might damage the gates and turbine runners or choking of nozzles of the impulse turbines. It is placed across the intake and is made of steel bars. (3)

vii) prime mover : The head of water is converted into the kinetic energy in prime mover, which rotates the shaft of the electric power generators (normally synchronous alternators). Thus a prime mover also called a turbine, converts the kinetic and potential energy of water into the mechanical energy. The commonly used water turbines are Francis, Kaplan, Propeller, Pelton. Normally water turbines rotate on the vertical axis.

viii) power house : Power house is normally located near the foot of the dam. It may be underground or open type. Water is brought to the power house with help of penstocks and passed to the turbines. These rotate the alternators. The location of the powerhouse is decided based on the maximum possible head at the turbine. In some locations underground power station may be more economical. In power house there are several in-house auxiliaries and controls.

ix) Spillway : It discharges the excess water of reservoir beyond the full permission level and acts as a safety valve of reservoir. If excess water is not discharged, water level of reservoir will be raised water may start flowing over the dam, a phenomenon known as overtopping. The spillways can be classified as a) overflow spillway b) side channel spillway c) emergency spillway d) chute or trough spillway e) shaft or siphon spillway.

* Classification of plants based on water flow regulation

According to this classification the plants may be divided into

- i) Run-off River plants without pondage.
- ii) Run-off River plants with pondage.
- iii) Reservoir plants.

i) Run-off River plants without pondage : As the name indicates this type of plant does not store water: the plant uses water as it comes. The plant can use water only as and when available. Since these plants depend for their generating capacity primarily on the rate of flow of water during rainy season high flow rates may mean some quantity of water to go as waste (i.e. without being used for generation of power) while during low run-off periods, due to low flow rates, the generating capacity may be impaired. A typical run-off river plant has a powerhouse

located with a weir spanning the river that also serves as the river flow regulator.

ii) Run-off river plants with Pondage : Usefulness of a run-off-river plant is increased by pondage. Pondage permits storage of water during the off-peak periods and use of this water during the peak periods. Depending up on the size of pondage provided it may be possible to cope, hour to hour with fluctuations of load throughout a week or some longer period. With Enough pondage the firm capacity of the plant becomes more. This type of plant can be used on parts of the load curve as required.

iii) Reservoir plants : A (storage) reservoir plant is that which has a reservoir of such size as to permit carrying over storage from wet season to the next highly season. Water is stored behind the dam and is available to the plant with control and regulation as required. Such plant has better capacity and can be used efficiently throughout the year. Its firm capacity is increased and it can be used either as a base load plant or as a peak load plant as required. It can be also used on any portion of the load curve as required. Majority of hydroelectric plants are of this type.

* Classification of plants based on water head

Hydroelectric plants may be classified into high-head, medium-head and low head plants. A plant may be classified as high head, if operating on head above 30 meters. Low head plants work under heads below 30 meters. Medium head plants are those lying between the above two classes.

i) High head plants : Due to high head, small amount of water can produce large amount of power. Therefore these types of plants are very economical. Normally the reservoirs are high up in the mountains and the powerhouse is located at the foot, taking advantage of large level difference.

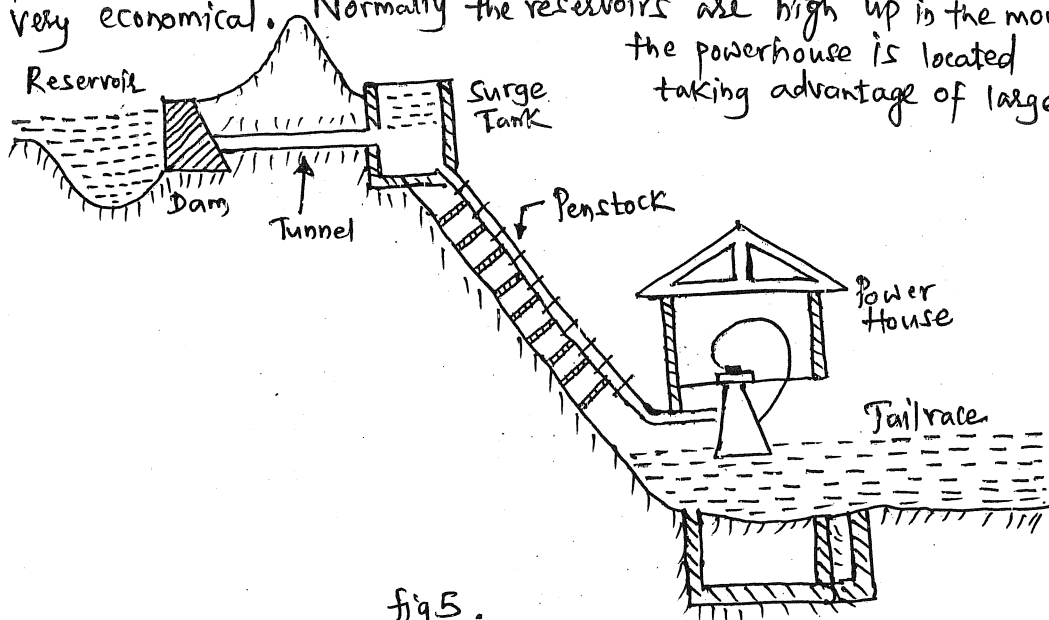

fig 5.

The catchment area is small and if water from one stream is not sufficient, then water from neighbouring streams can be diverted to the lake through the pipelines or tunnels. The water is carried from main reservoir by tunnel to powerhouse via surge tank. The length of conduit system may be 15 km or more. For heads above 500m, pelton turbine are used and Francis turbines are common for low head.

Medium head plant : Larger volume of water is needed in such plants as compared to high head plants. Therefore, a reservoir of large capacity with large catchment area is required. In these plants water is generally carried from main reservoir to the forebay and then to powerhouse through the short penstocks. There is no need of surge tank as forebay itself acts as surge tank.

Generally there is one penstock per turbine. Francis, Kaplan and propeller type of turbines are common for the medium head plants.

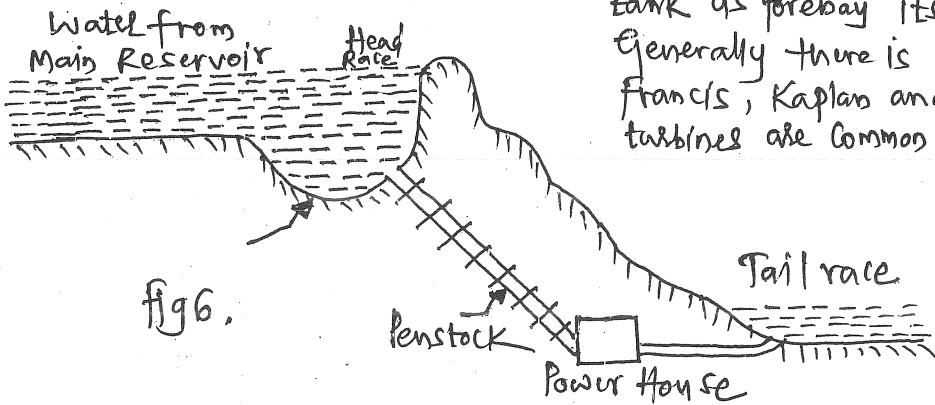

fig 6.

Low Head plants : To generate the same amount of power in such plants water required is much larger than the high head power plants. Generally run-off river plants, tidal plants & midget plants fall into this category.

The catchment area and the magnitude of peak flood are very large, the spillway length being considerable.

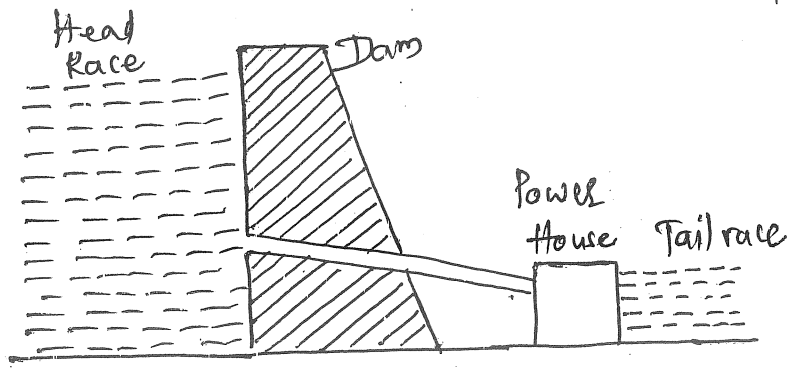

fig 7.

Francis, Kaplan or propeller turbines are used for low head plants. The size of turbine and powerhouse are large. No surge tank is required. Here in this case usually a small dam is built across the river to provide necessary head. The excess water is allowed to flow over the dam itself.

* Classification of plants based on type of load the plant has to supply
Hydroelectric plants may be classified into base load, peak and pumped storage plants for peak load.

* Base load plants : Such ^{plants} load can take up load on the ^{base} portion of the load curve. These are generally of large capacity. Since such plants are kept running practically on block load the load on them is almost constant. Load factor of such plants is therefore high. Run-off river plants without pondage can be used as base load plants. Similarly those plants which have large storage are ideally suited to work as base-load plants, particularly during the rainy-season when water level of reservoirs due to rains will be high. In other words a hydro ~~pea~~ electric plant work as a base load plant if there is continuous power generation.

* Peak load plants : Run-off-river plants with pondage can be used as peak-load plants. In case there is enough a large portion of the load can be supplied by such plants. Reservoir plants with enough storage behind the dam can be used either as base load or as peak-load plants as required. If the conditions prevailing at the power station permit regulated release of water, plant can be used to generate peak power. (Plants used to supply the peak load of the system corresponding to the load at the top portion of the load curve are known as peak-load plants).

* pumped storage plants for peak load : These plants are used when quantity of water available for generation of power is otherwise insufficient. If it is possible to pond at head water and tailwater locations water after passing through the turbine is stored in the tailrace pond from where it may be pumped back to the head water pond. The pumping back from the tailrace pond to the headwater pond is done during off-peak period. During the peak load period water is drawn from the head water pond through the penstock to operate turbines. The general arrangement of a pumped storage plant is shown in fig 2. Such plants can recover almost 70% of power used in pumping the water. Advantage of pumped storage plant is that it decreases the operating cost of the steam plant when working in combination with it because it serves to increase the load factor of the steam plant and provides added capacity to meet peak loads.

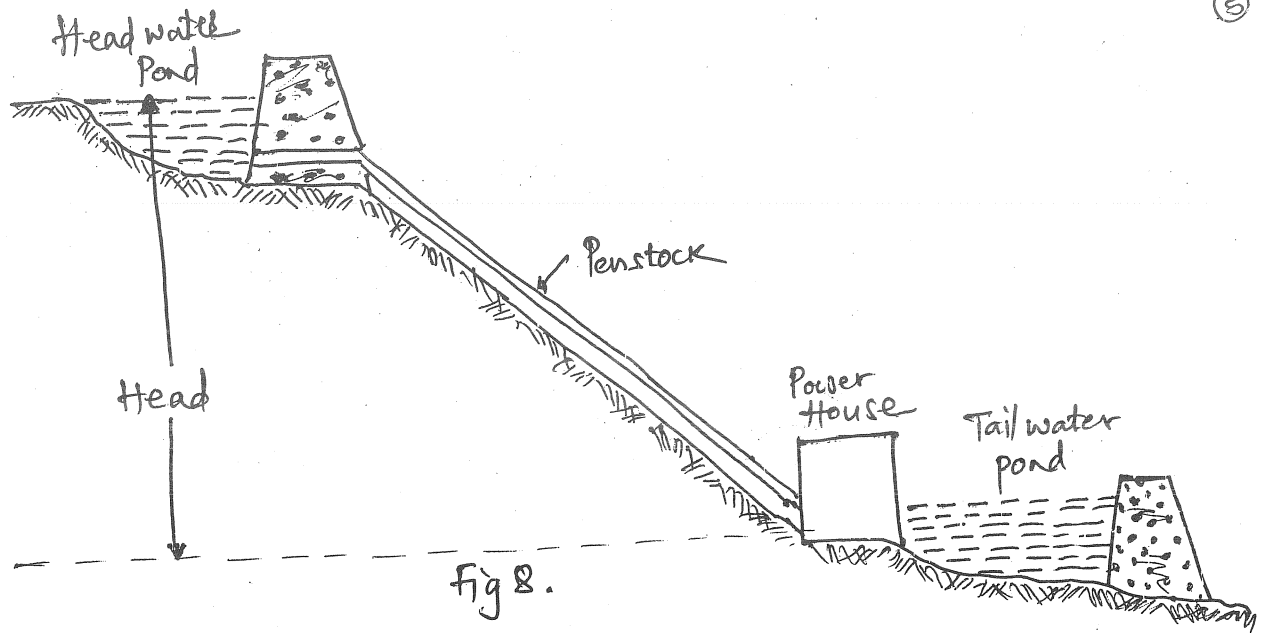

* Water Turbines :

Water Turbines, which convert water energy into mechanical energy, can be considered as motors run by water. The main function of water turbines is to rotate the generator coupled to it to produce electricity.

Basically the water turbines can be divided into two main categories: the impulse type and reaction type. Water flows out of a nozzle, in case of impulse type, in the form of a jet such that all the pressure energy is converted into kinetic energy. The jet strikes the series of the buckets mounted on the periphery of the wheel. Because of the impact, the runner is rotated about the axis. Therefore the turbine is called the impulse turbine. Since the pressure throughout the turbine is at the atmospheric that is constant, the impulse turbine is also called a constant pressure turbine. Pelton turbine is an impulse turbine.

Reaction turbine works on the principle of reaction. Water enters the turbine at high pressure and low velocity, some energy is converted into kinetic energy and water then enters the runner and pressure energy is successively converted into the kinetic energy. Water flowing through the runner creates a reaction on the runner vane and runner is rotated. In reaction turbine, water is under pressure and turbine is filled with water when working. Therefore a casing is must is an impulse turbine so that water cannot splash out. Reaction water turbines usually have vertical arrangement. Since water can be admitted all over the runner at one time is a reaction turbine, it is sometimes also called full admission turbine. Propeller, Francis, Kaplan and more recently Deriaz turbines fall in this category.

3, 4, 6, 7, 12, 15, 16, 19, 24, 28, 29, 38, 43, 45, 46, 50, 54, 64,

* Pelton wheel :

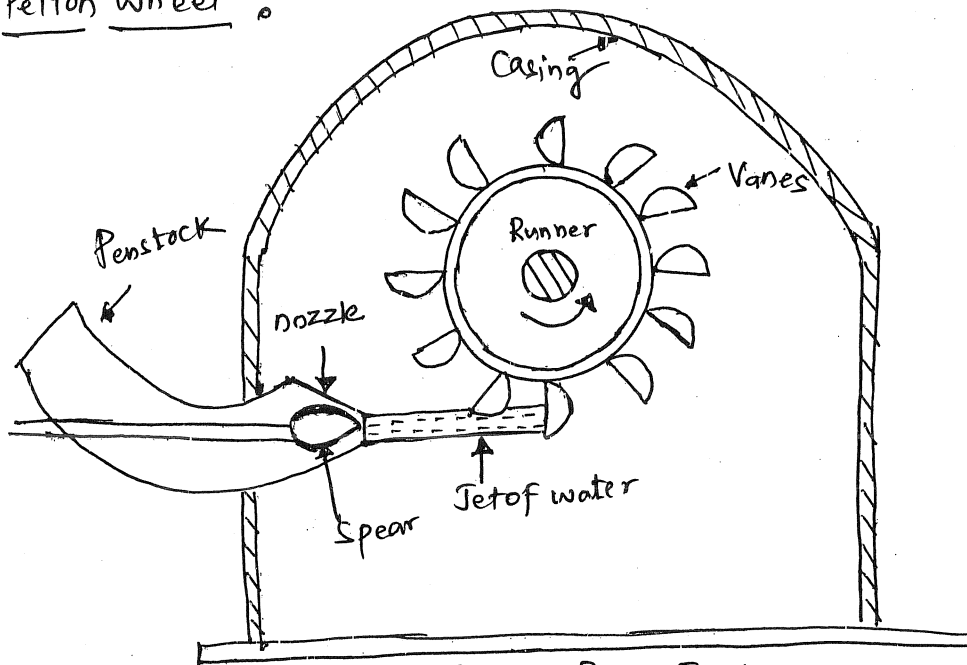

fig. 9. Pelton Turbine

Pelton wheel is an impulse turbine and it is suitable for high head and low flow plants. The potential energy of water in the penstock is converted into kinetic energy as a water jet issuing from a nozzle as shown in fig 9 above. Pelton wheel consists of rotor equipped with elliptical shaped buckets along the periphery of the turbine. The water jet impinges on the buckets, this impulse force causes the motion of the rotor. After doing useful work water discharged to the tail race. The quantity of water discharged through the nozzle is controlled by controlling the nozzle opening by means of needle placed in the nozzle tip. The movement of ^{the} tip is controlled by the governor. When the load on the turbine reduces the governor pushes the needle into the nozzle, thereby reducing the quantity of water striking the buckets. When load on the turbine increases, the reverse action will take place.

* Francis Turbine :

The Francis turbine is a reaction turbine as shown in fig 10. It is a inward radial flow turbine in which water at inlet possessed both kinetic and pressure energies. As water flow through the runner, a part of pressure energy goes ^{on} converting into kinetic energy. Thus the water through the runner is under pressure. It consists of casing, guide mechanism, runner and draft tube as shown in fig 10.

As water from the casing enters the stationary guiding mechanism. The guiding mechanism consists of guide vanes or blades which

The water to enter the runner which consists of moving vanes. The water flows over the moving vanes in the inward radial direction and is discharged at the inner diameters of the runner. Outer diameter of the runner is inlet and the inner diameter of the runner is the outlet. For regulating the quantity of water entering the turbine, the guide blades are provided about an axis so that, by turning them in one or other direction simultaneously, the passage may be varied to control the speed automatically by using servomechanism. The exit of the Francis turbine is connected with draft tube, which allow the water to enter the tail race. The turbine shaft is connected to the alternator which rotates along with turbine to generate the electric power.

* Kaplan Turbine : Spiral casing, Runner, Water from penstock

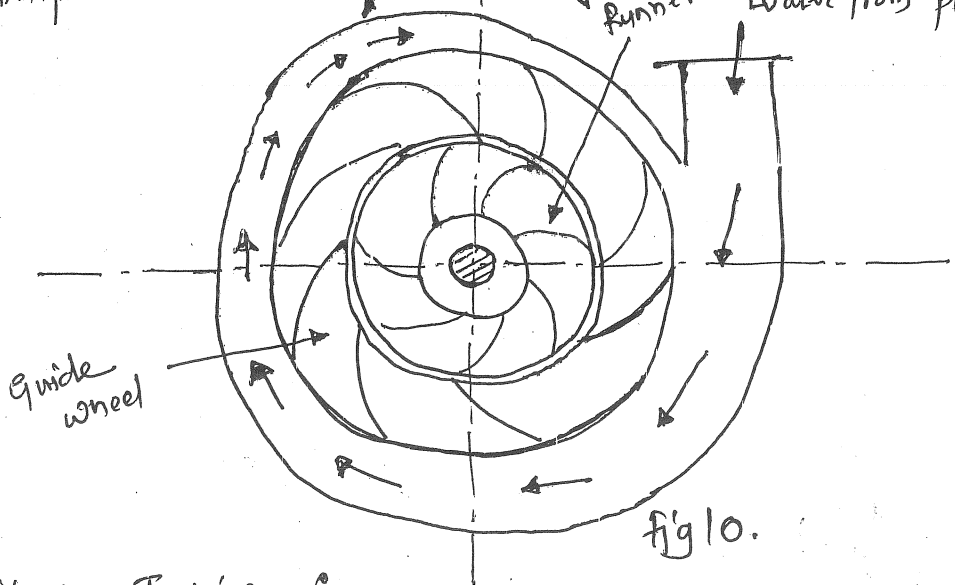

* Kaplan Turbine :

The Kaplan turbines are essentially a low head turbines (for heads upto 100 ft). These turbines are also known as reaction turbines and requires large quantity of water. The Kaplan turbine is a axial flow reaction turbine as shown in fig 11a. In which the shaft of the turbine is vertical provided with hub at lower end. The vanes are fixed on the hub and acts as a runner. These vanes are adjustable. The Kaplan turbine consists of a spiral casing, guide mechanism, runner and draft tube. The water from the penstock enters the spiral casing and then moves to the guide vanes. From the guide vanes the water turns through 90° and flows axially through the runner as shown in fig 11. and discharges to the tail race through the draft tube. The flow can be controlled by adjusting the gate opening & blade angle simultaneously by governing mechanism.

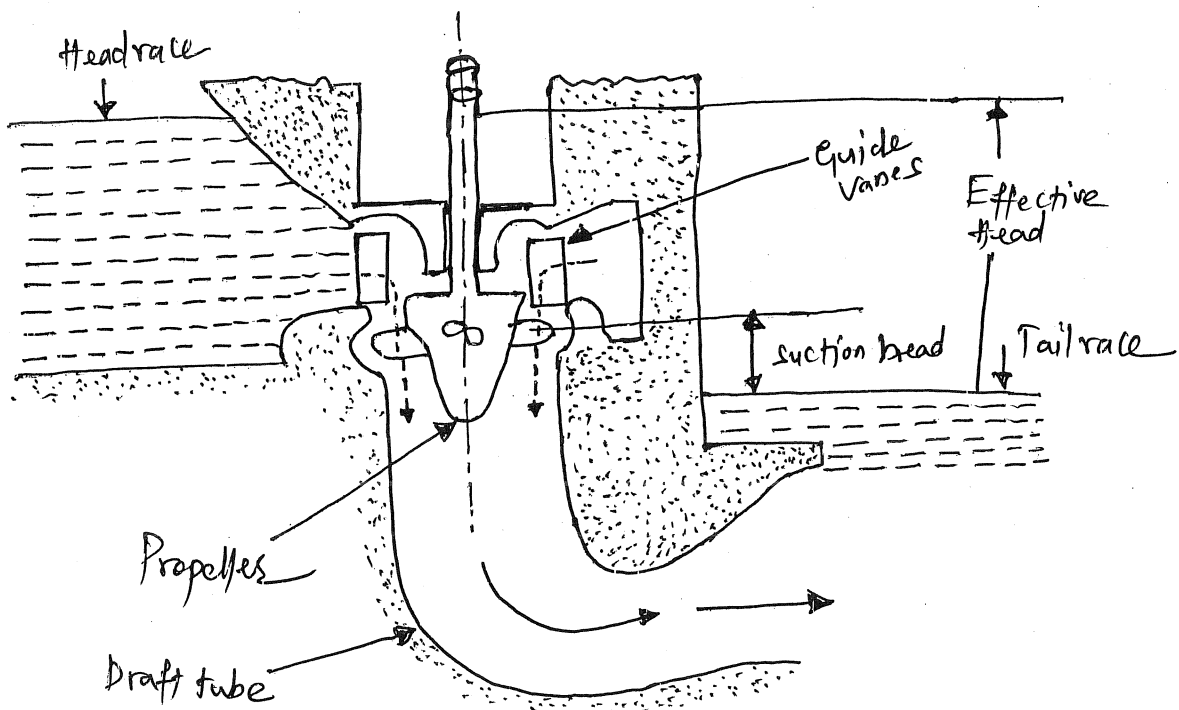

fig 11a. Kaplan Turbine

* Propeller Turbine :

The propeller turbine is a reaction turbine used for low heads (4m-80m) and high specific speeds (300-1000). It is an axial flow device - providing large flow area utilizing a large volume flow of water with low flow velocity. It consists of an axial-flow runner usually with four to six blades of airfoil shape (fig 11b). The spiral casing and guide blades are similar to those in Francis turbines. In propeller turbines as in Francis turbines the runner blades are fixed and nonadjustable.

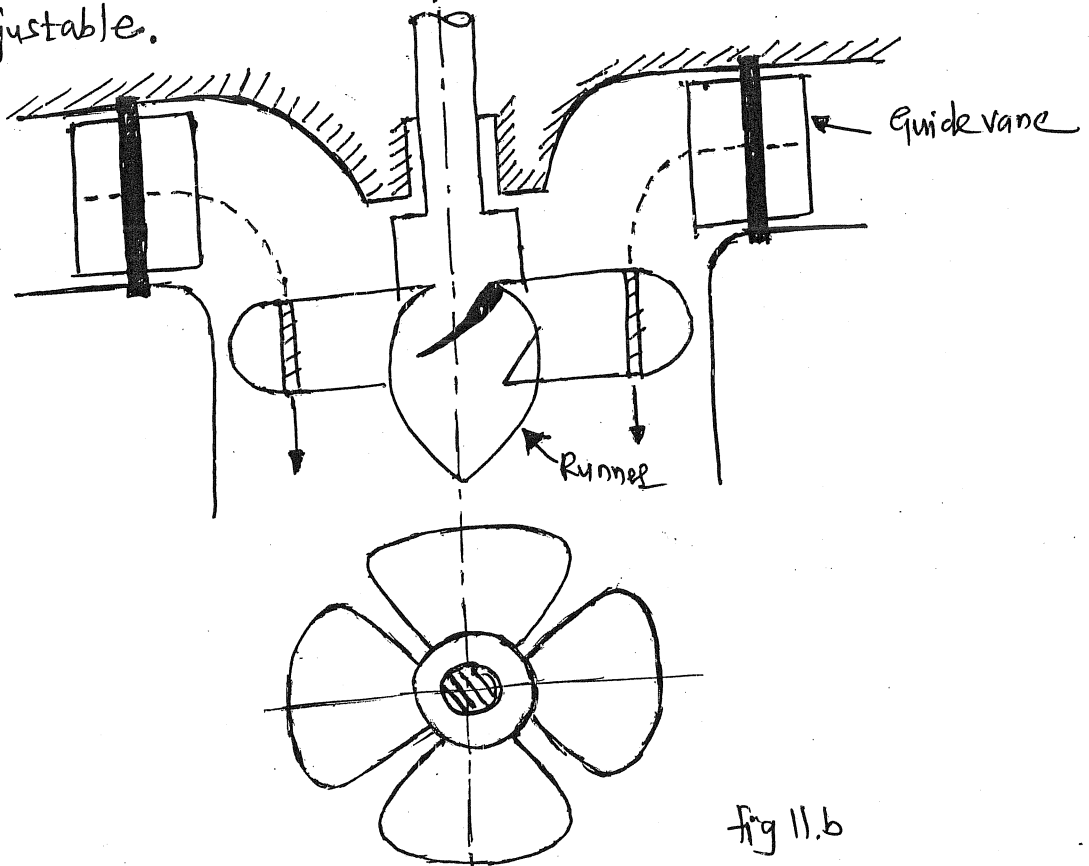

fig 11.b

* Characteristics of turbines :

i) Head : For heads above 500 meters reaction turbines of various types are used. For heads above 500 meters upto about 2000 meters pelton wheels are used.

Head and other Conditions	Type of Turbine
(a) Heads lower than 30 meters and for variable load operation	Kaplan or movable vane propeller
(b) Heads less than 70 meters and for fairly constant load operation	Fixed vane propeller
(c) Heads 70 to 500 metres	Francis

ii) Efficiency at variable loads : Fig. 12 a and 12 b show typical efficiency curves for an impulse turbine (Pelton wheel) and different types of reaction turbines.

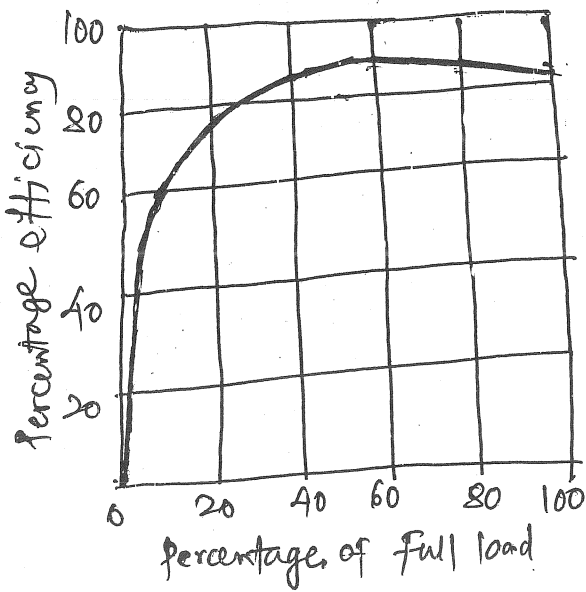

Fig 12 a

Efficiency curve of an impulse turbine

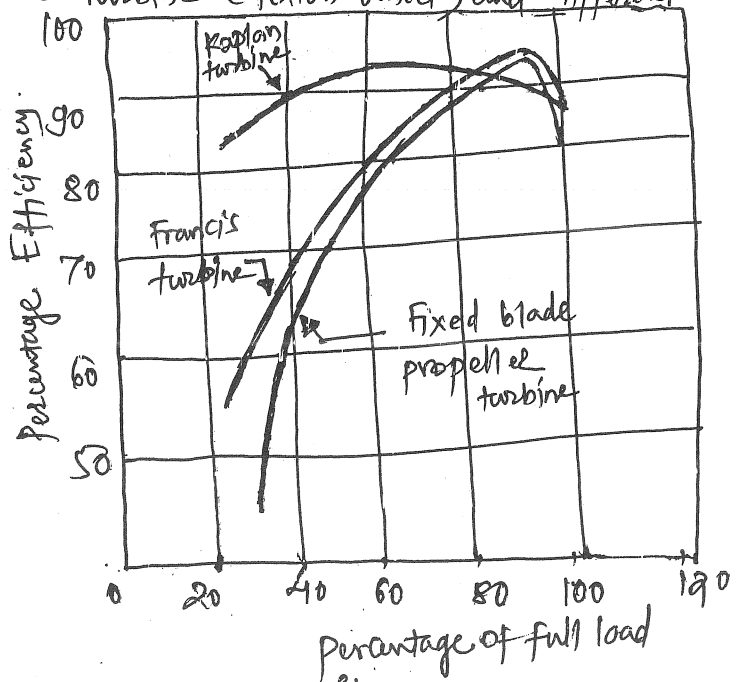

Fig 12 b

Efficiency curve of reaction turbine of various types

iii) Specific speed : This is defined as that speed at which a turbine would run when developing 1 metric horse power under a head of 1 meter. It can be shown that if n_s , n , P and h denote respectively the specific rotational speed, actual rotational speed, metric hp (= 736 watts) and head in meters respectively.

$$n_s = \frac{n P^{1/2}}{h^{5/4}} \text{ revolutions per minute}$$

Further, if power is expressed in kW the above expressions becomes

$$n_s = 1.165 \frac{n (kW)^{1/2}}{h^{5/4}} \text{ revolutions per minute}$$

ordinary ranges of n_s are as follows —

pelton wheel	12-70
Francis	80-420
Propeller and Kaplan	310-1,000

iv) Turbine setting : A pelton wheel is always set at a higher level than (usually at least two meters above) the ~~tail~~ highest tail race level. As against this a Francis turbine runner should be placed at a level very near or below the lowest tail race level.

v) Runaway Speed : This is the maximum speed at which a turbine wheel would run under the worst condition of operation at which with all gates open so as to allow all possible water inflow under maximum head. (The worst condition corresponds to load on the generator being suddenly thrown off and governor failing to act) This must be taken into account and the generator coupled to turbine must be able to withstand the full runaway speed of the turbine under maximum permissible speed.

* Governing of Turbines :

All hydraulic modern turbines are directly coupled to electric generators. Irrespective of variations in the load the generators are required to run at a constant speed which is fixed by the number of pairs of poles and required frequency. However when the load on the generator varies there will be corresponding variations of load on the turbine also. If the input to the turbine remains the same the speed of the runner will tend to increase or decrease depending on whether there is a decrease or an increase in the load. This will cause the speed of the generator also to vary which is however not desirable. In order that the generator may always run at a constant speed, the speed of turbine runner must be maintained constant. This is usually done by regulating the flow of water passing through the runner in accordance with variations in the load. Such an operation of speed regulation is known as governing; it is done automatically by means of a governor. One of the common types of governors predominantly used with modern turbines is oil pressure governor.

The component parts of such a governor are

- i) servomotor also known as relay cylinder.
- ii) Relay valve also known as control valve or distribution valve.

iii) Actuator or pendulum which is belt or gear driven from the turbine main shaft.

(8)

iv) oil sump

v) oil pump which is driven by belt connected to turbine main shaft.

vi) A system of oil supply pipes connecting oil sump with the relay valve and relay valve with servomotor.

The working of oil pressure governor will be clear with reference to figure 13. The servomotor or relay cylinder has a piston moving under the action of oil pressure. First the movement of the piston rod is amplified and translated to the controlling device of the turbine. The distributing valve is actuated by the speed responsive elements of the governor and controls the supply of oil to the cylinders. The actuator is a flyball mechanism working as the speed responsive element. As stated it is driven from the turbine main shaft. Oil is pressurised by the oil pump.

Suppose the speed of the turbine falls. This will result in the sleeve on the actuator shaft descending and causing the main lever to raise the pistons of the distributing valve. As a consequence oil under pressure would be sent to one end of the oil cylinder and this would move the piston to one side. As would be clear from the figure this movement would be transmitted to the controlling device to open the nozzle of the impulse turbine or guide vanes of the reaction turbine. When the turbine speed rises reverse action would take place. As long as speed of the turbine remains normal the main lever, the pistons in distributing valve and relay cylinder will occupy their normal positions.

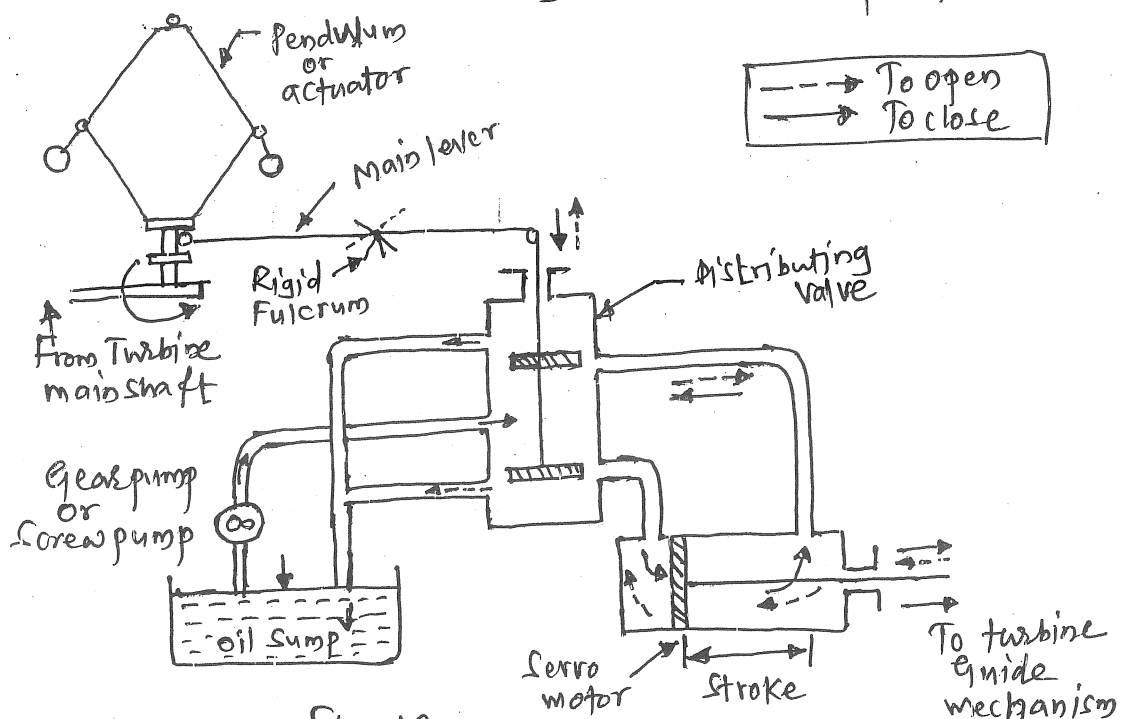

fig. 13

* Selection of water Turbines :

The hydraulic turbine is selected according to the specific conditions under which it has to operate and attain the maximum possible efficiency. The choice depends on the head available, power to be developed and the speed at which it has to run. The following factors basically govern the selection of a suitable type of turbine.

i) operating head : The present practice is to use Kaplan and propeller type of turbines for heads up to 50m. For head from 50 to 400m, Francis turbines are used. For heads greater than 400m, impulse or Pelton turbines are used. The range of heads as mentioned is not rigid and may change if other conditions dominate to achieve economy.

ii) Specific speed : It is better to choose turbines of high specific speeds. High speed turbines means small sizes of turbines, generators, power house, etc. and therefore, more economical. The range of specific speeds of the turbines should correspond to the synchronous speed of the generator, $N = \frac{120f}{p}$, where f is the frequency and p the number of poles.

iii) Height of installation : It is better to install the turbines as high above the tail water level (TWL) as possible. This saves the cost of excavation for the draft tube. Care should be taken to ensure that cavitation does not occur.

iv) Performance characteristics of turbine : The performance characteristics of turbines (i.e. constant head characteristic curves, constant speed characteristic curves, constant efficiency curves) should be studied carefully before recommending the type of turbine to be used. A turbine has the maximum efficiency at a certain load. When a turbine has to operate mostly at part loads, only those turbines whose efficiencies do not fall appreciably with part loads should be selected. Kaplan and Pelton turbines are better than Francis & propeller turbines in this respect.

v) Size of turbine : It is better to go in for as large a size of turbine as possible since this results in economy of size of the powerhouse, the number of runners penstocks, the generator, etc. Bigger size means less number of runners. However, the number of runners should not be less than two so that at least one unit is always available for service in the case of a plant breakdown.

* Underground, small hydro & pumped storage plants :

(9)

Underground : An underground power station is a type of hydroelectric power station constructed by ^{removing} excavating the major components (eg. machine hall, penstocks, & tailrace) from rock, rather than the more common surface-based construction methods. One or more conditions impact whether a power station is constructed underground. The terrain or geology as gorges or steep valleys may not accommodate a surface power station. A power station within bedrock may be more ~~ex~~ inexpensive to construct than a surface power station on loose soil.

Often underground power stations form part of pumped storage hydroelectricity schemes. Their basic function is to level load. They use cheap off-peak power to pump water from a lower lake to an upper lake. Then, during peak periods (when electricity prices are often high), the power station generates power from the water held in the upper lake.

Small hydro :

As the name implies, small hydro is the smaller version of large hydro. According to Central Electricity Authority of India & Bureau of Indian Standards, small hydroelectric power stations are classified as follows:

(a) Depending on capacity

Micro plant is upto 100 kW

Mini plant is from ~~100 to 1000 kW~~ - plant rating is more than 100 kW & less than 2 MW

Small plant is from ~~100 to 6000 kW~~
2 MW to 25 MW

(b) Depending upon head

Ultra low head : below 3 m

Low head : less than 30 m

Medium head : between 30 and 75 m

High head : above 75 m

Unlike other renewable energy sources, small hydro is not something that has been invented recently, but is, in fact, one of the technologies mankind has been using since centuries, just as it has been using wind energy, biomass, geothermal & solar energy. The first ever small hydro unit for generating electricity was commissioned in India in 1897 at Darjeeling. It had a capacity of 130 kW & is still operating today. Another small hydropower in 1902 to supply power to the Kolar gold mines. Power generated with small hydro station can be used for agro processing, local lighting, water pumps and small businesses.

* pumped storage plants.

The pumped storage plants are a special type of power plants which works as an ordinary conventional hydropower stations.

* These plants generate electricity during the peak load hours, called generating phase & pump the water back from tailrace to reservoir during off peak hours known as pumping phase.

* During the peak load period water is drawn ~~thru~~ from head water pond through penstock in order to operate turbine.

* The general arrangement of a pumped storage plant is as shown below.

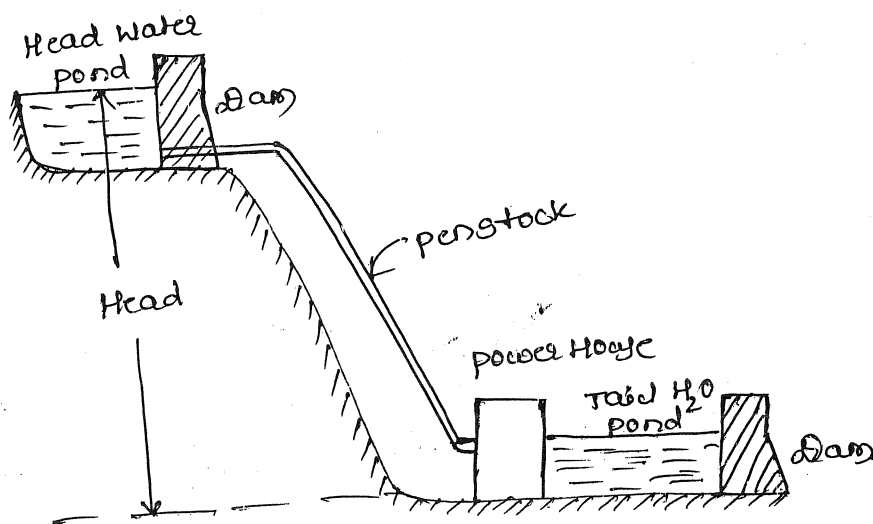

fig - pumped storage plant.

* The pumped storage plant have following advantages

- 1) As compared to other peaking units, pump storage plants are economical.
- 2) pumped storage plants are free from environmental pollution.
- 3) It offers great flexibility in operation.
- 4) These plants allow other units to run as base load and thus improve the overall efficiency of the slm.

* The drawbacks of storage plant are

- 1) They have to be operated in narrow range of rated capacity to obtain the maximum efficiency.
- 2) Time interval required is about to full load ~~the~~

from the complete shut down.

(10)

* choice of size and number of generating units

The load on the power station is never constant & it varies at different timings of the day. ∴ The generating plant should have the capacity to meet the maximum demand.

* For example one unit is taken of certain size to meet the maximum demand of power station, then the plant will be operating on full load, only for short duration and it will be operating on no load condition for rest of the day.

* ∴ The generating unit will not be operating at all the times only it operates during best conditions giving - maximum efficiency.

* In isolated station, in order to maintain reliability and continuity of power supply at all the times, another unit of equal capacity is required. ∴ the capital cost is considered for both the units.

* However the capital cost includes the cost of both the units, the capacity of each of unit is corresponding to the maximum load on power station.

* Alternatively number of small sized generating units can be chosen in order to fit the load curve as closely as possible, i.e. the generating units are selected of such sizes & in such number that they work on suitable portions of the load curve, in such a way that, each unit will operate on full load.

* during such condition one unit of the largest size is chosen, & this unit would be much smaller than the maximum load capacity required.

- * The alternative will require large number of generating units & area required is also more & cost is more.
- * \therefore compromise is to be made during the selection of size & no. of generating units in generating station.
- * The aim should have small number of units & to fit them as well as possible on the load curve.
- * Neither we should go for single generating unit of larger capacity nor for a large number of generating units of smaller size.

* Layout of Hydro power plant.

The general layout of hydro power plant is determined by its type.

- * For the plants consisting of vertical turbing, the most convenient and economical layout will be with turbines installed in line parallel to the length of the turbine house as shown in below fig.

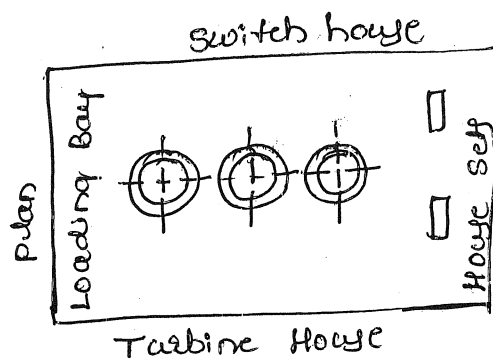

fig- Layout of Hydro power plant with vertical section turbing

The spacing b/w the machinery will depend upon the size of scroll case, width of flume or by means of overall diameter of alternators.

- * In case of turbing with horizontal shaft arrangement, the most suitable layout will be, placement of

tubing right angles to the length of turbine house. (11)

* The horizontal marking can also be placed \perp to the longitudinal axis of turbine house.

* Hydro plant Auxiliary.

The auxiliary essentially required for hydro-electric power plant are governor, cranes, lubricating oil pumps, drainage & dewatering pumps, valves, battery charging units, CO₂ cylinder etc.

* These auxiliary are electrically driven.

* Water is used to cool bearings of the turbine, generators & the transformer, & it is circulated through water pumps.

* Air compressors maintain supply of air under pressure for operation of generator brake & other uses in the power station.

* Fans are required for ventilation of the turbine, cooling of transformer.

* Oil pumps handle transformer oil through the clearing & cooling system.

* Cranes are required to fit heavy parts or place them in position during repairs.

* Water pumps are required for unwatering of turbine pits during repairs or during inspection.

* Storage batteries are required to supply low voltage dc power for switchgear control; these batteries are constantly charged through a battery

charging equipment using a rectifier or motor generator set.

* The supply for the above auxiliary is usually obtained from the station transformer.

* Environmental Impacts of Hydro power plants.

Even though the hydroal power plants are considered as clean & harmless but they have following environmental impacts

- 1) Hydro electric power plants require large quantity of water for power generation, hence the dams are to be constructed, which leads to displacement of the inhabitants of the area, which leads to some social & economic problems.
- 2) The dams change local ecological conditions, vary the amount of pressure applied to the ground land, & the ground water level, which adversely affect the plant and animal life nearby region.
- 3) The construction of hydroelectric power plant slows down the flow of water from rivers and they cause the pollution of water, cause the growth of blue green algae, encourage the reproduction of bacteria.
- 4) Large area acquisition means ~~destruction~~ of forest, which is harmful to environment.
- 5) Large number of workers required for construction are brought into area and disturb the very nature of local population.

Module 2

Steam Power Plants, Diesel power plant, Gas Turbine Power Plant* Steam Power Plants :

* Introduction : The use of steam power started when it was first used in locomotives invented by James Watt. Thereafter, the steam power is used to rotate the prime mover of electric generator and it is known as steam power plant. In this process heat energy is converted into mechanical energy and then to electrical energy through turbine-generator system. Heat energy may be obtained by the proper combustion of a commercial fuel such as coal, gas, oil etc. Since abundant availability with reasonably no cost, water is used to generate steam, which readily conveyed through pipes, is a boiler by burning fuel in furnace. Steam power plants are also called thermal power plants. The prime movers of steam power plants may be operated either in noncondensing or condensing. In other words the noncondensing operation, the steam is exhausted from the prime movers and is discharged at atmospheric pressure or at greater than atmospheric pressure. Where as in condensing plant, the prime movers exhaust discharge steam into a condenser in which the pressure is less than atmospheric and steam is converted into water. This is most commonly used in modern age power plants.

* Efficiency of steam power plants : The overall efficiency of a steam power station is quite low (about 29%) due to mainly two reasons. Firstly, a huge amount of heat is lost in the condenser and secondly heat losses occur at various stages of the plant. The heat loss in the condenser cannot be avoided. It is because heat energy cannot be converted into mechanical energy without temperature difference. The greater the temperature difference, the greater is the heat energy converted into mechanical energy. This necessitates to keep the steam in the condenser at the lowest temperature. But we know that, the greater the temperature difference, greater is the amount of heat lost. This explains for the low efficiency of such plants.

i) Thermal efficiency : The ratio of heat equivalent of mechanical energy transmitted to the turbine shaft to the heat of combustion of coal is known as thermal efficiency of steam power station.

$$\text{Thermal efficiency, } \eta_{\text{thermal}} = \frac{\text{Heat equivalent of mechanical energy transmitted to turbine shaft}}{\text{Heat of coal combustion}}$$

The thermal efficiency of a modern steam power station is about 30%. It means that if 100 calories of heat is supplied by coal combustion, then mechanical energy equivalent of 30 calories will be available at the turbine shaft and rest is lost. It may be important to note that more than 50% of total heat of combustion is lost in the condenser. The other heat losses occur in flue gases, radiation, ash etc.

ii) Overall efficiency: The ratio of heat equivalent of electrical output to the heat of combustion of coal is known as overall efficiency of steam power station i.e.

$$\text{Overall efficiency, } \eta_{\text{overall}} = \frac{\text{Heat equivalent of electrical output}}{\text{Heat of Combustion of coal}}$$

The overall efficiency of steam power station is about 29%. It may be seen that overall efficiency is less than the thermal efficiency. This is expected since some losses (about 1%) occur in the alternator. The following relation exists among the various efficiencies.

$$\text{Overall efficiency} = \text{Thermal efficiency} \times \text{Electrical efficiency}$$

* Merits and Demerits of plants

Merits:

- i) The fuel (i.e. coal) used is quite cheap.
- ii) Less initial cost as compared to other generating stations.
- iii) It can be installed at any place irrespective of the existence of coal. The coal can be transported to the site of the plant by rail or road.
- iv) It requires less space as compared to the hydroelectric power station.
- v) The cost of generation is lesser than that of the diesel power station.

Demerits:

- i) It pollutes the atmosphere due to the production of large amount of smoke and fumes.
- ii) It is costlier in running cost as compared to hydroelectric plant.

* selection of site:

Following are the factors to be considered for the site selection of thermal power plant and installation of its equipments.

i) Supply of fuel: The steam power stations should be located near the coal mines so that transportation cost of fuel is minimum. However, if such a plant is to be installed at a place where coal is not available, then care should be taken that adequate facilities exist for the transportation of coal.

ii) Availability of water: As huge amount of water is required for the condenser, therefore, such a plant should be located at the bank of a river or near a canal to ensure the continuous supply of water.

iii) Transportation facilities : A modern steam power station often requires the transportation of material and machinery. Therefore, adequate transportation facilities must exist i.e., the plant should be well connected to the other parts of the country by rail, road etc.

iv) Cost and type of land : The steam power station should be located at a place where land is cheap and further extension, if necessary, if possible. Moreover, the bearing capacity of the ground should be adequate so that heavy equipment could be installed.

v) Nearness to load centres : In order to reduce the transmission cost, the plant should be located near the centre of the load. This is particularly important if d.c. supply system is adopted. However, if a.c. supply system is adopted, this factor becomes relatively less important. It is because a.c. power can be transmitted at high voltages with consequent reduced transmission cost. Therefore it is possible to install the plant away from the load centres, provided other conditions are favourable.

vi) Distance from populated area : A huge amount of coal is burnt in a steam power station, therefore, smoke and fumes pollute the surrounding area. This necessitates that the plant should be located at a considerable distance from the populated areas.

* Working of steam plant :

A steam power station basically works on the principle of Rankin cycle. Steam is produced in the boiler by utilising the heat of coal combustion. Then the steam is conveyed to the prime mover (steam turbine) and it is condensed in a condenser to be fed into the boiler again. The steam turbine drives the alternator (electric generator) which converts the rotary mechanical energy into electrical energy.

The prime movers of steam power plants may be operated either in ~~is~~ non condensing or condensing.

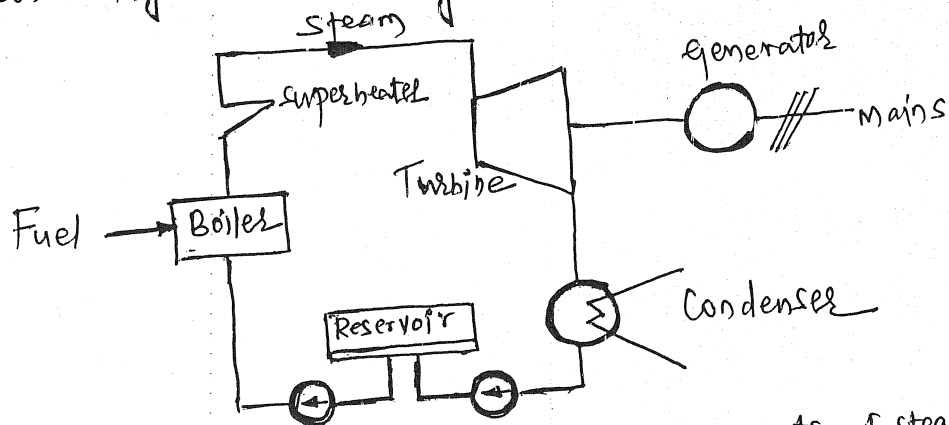

fig 1. Major components of steam power plant

* Power Plant Equipment and Layout :

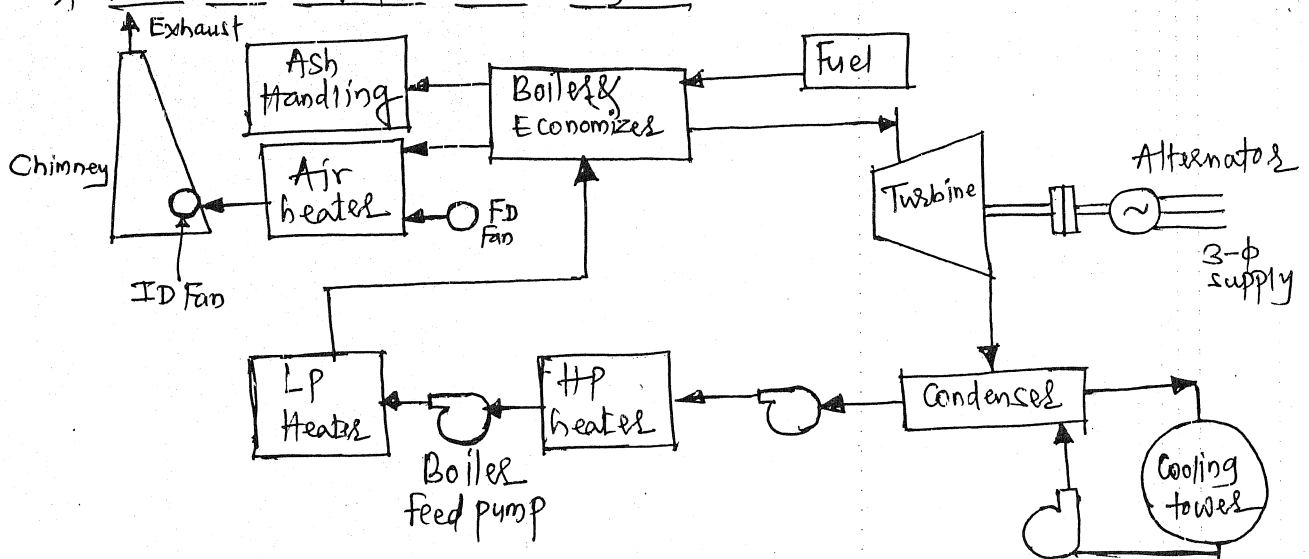

Fig 2. Layout of typical steam power plant

Boiler : Boiler, which is the second tallest part after the chimney in a steam power plant, is used for producing the steam under pressure and reheating it, i.e. heat of combustion of coal in the boiler is utilised to convert water into steam at high temperature and pressure. The fine gases from the boiler makes their journey through superheaters, economiser, air preheaters and finally exhausted to atmosphere through the chimney.

Economiser : An economiser is essentially a feed water heater and derives heat from the fine gases for this purpose. The feed water is fed to the economiser before supplying to the boiler. The economiser extracts a part of heat of fine gases to increase the feed water temperature.

Air preheaters : Since the entire heat of the fine gases cannot be extracted through the economiser, air preheaters are employed to recover some of the heat in these gases. It increases the temperature of the air supplied for the coal burning by deriving heat from the fine gases. Air is drawn from the atmosphere by a forced draught fan (FD) and is passed through air preheater before supplying to the boiler furnace. Air preheater extracts heat from fine gases and increase the temperature of air used for coal combustion. The principal benefits of preheating the air are: increased thermal efficiency and increased steam capacity per square meter of boiler surface.

Superheaters and Reheaters : The steam produced in the boiler is wet and is passed through a superheater where it is dried and superheated (i.e., steam temperature increased above that of boiling point of water) by the the fine gases on their way to chimney. In other words a superheater is a device which removes the last traces of moisture (1 to 2%) from the

From the saturated steam leaving the boiler tubes, and by increasing its temperature sufficiently above saturation temperature. Superheating provides two principal benefits. Firstly, overall efficiency is increased. Secondly too much condensation in the last stages of the turbine (which would cause blade corrosion) is avoided. The superheated steam from the superheater is fed to steam turbine through the main valve.

(Note: Here the steam that exists at the vaporization temperature corresponding to its absolute pressure is defined as saturated steam, which may or may not carry water with it).

A Reheater is essentially a superheater as it is designed to bring the partially expanded steam back to superheat temperature by passing it through the tubes.

Steam prime mover (steam turbine): Steam turbines are usually employed as prime movers. The dry and superheated steam from the superheater is fed to the steam turbine through main valve. The heat energy of steam when passing over the blades of the turbine is converted into rotational mechanical energy. In steam turbine the steam expands in the stationary nozzles and attains a higher velocity. There are several stationary blades and moving blades. The steam pressure is gradually reduced in the blades as the steam passes through them. After giving heat energy to the turbine, the steam is exhausted to the condenser.

Alternator (synchronous generator): The steam turbine is coupled to an alternator. The alternator converts ^{rotary} mechanical energy of turbine into electrical energy. The electrical output from the alternator is delivered to the bus bars through transformers, circuit breakers & isolators.

Condenser: In order to improve the efficiency of the plant, the steam exhausted from the turbine is condensed by means of a condenser. Water is drawn from a natural source of supply such as a river, canal or lake and is circulated through the condenser. The circulating water takes up the heat and is circulated of the exhausted steam and itself becomes hot. This hot water coming out of the condenser is discharged at a suitable location down the river.

In case the availability of water from the source of supply is not assured throughout the year, Cooling towers are used. During the scarcity of water in the river, hot water from the condenser is passed on to the cooling towers where it is cooled by dividing ^{the} water in smaller quantities practically of the size of drops. These water drops fall from a height of 8 to 10 meters to the bottom of the cooling tower. The cooled water from the base of cooling tower is reused in the condenser & the cycle is repeated.

* Steam turbines :

- The steam turbine has several advantages over steam engine as a prime mover. It has higher thermodynamic efficiency since steam can be expanded to a lower final temperature than is possible in a steam engine. The basic construction of a steam turbine is simple. There is no need of piston rod mechanism and slide valves; no flywheel is needed. Also steam turbine can be built in large sizes as much as 1000 MW. No-wearing action being involved maintenance of a steam turbine is comparatively much simple. Problems of vibrations is also much less since high operating speeds results in a lower weight of rotating parts for the same power.
- The steam turbines are generally of two types - impulse & reaction. In an impulse turbine the steam expands in the stationary nozzles and attains a higher velocity. Potential energy in steam due to pressure and internal energy is converted to kinetic energy when passing through the nozzles. There are a number of stationary blades and moving blades. A reaction turbine has no nozzles. This type of turbines also has fixed and moving blades. A partial drop of pressure is used to allow the steam into the moving blades. The pressure is gradually reduced in the blades as the steam passes through them. Commercial turbines use series combination of impulse and reaction types because steam can be used more efficiently by using impulse and reaction blading on the same shaft. The steam is expanded through the turbine from a high pressure at the throttle valve to a back pressure corresponding to a vacuum of 71 to 73.5 cm Hg or an absolute pressure of 5 to 2.5 cm Hg.
- Impulse or reaction or mixed arrangement of both these are the types of steam turbines used for power station purposes. The rotor shaft of the turbine is made of forged steel and the turbine blading is fixed on to it in the required number of stages. The blades are milled from solid steel blocks. The bottom and top halves of casing contain the stationary blades. Two to four extractions are usual though actual number depends on economic use of the hot steam for feed water heating or in evaporators.
- Vacuum in the condenser: A vacuum of 70-73.5 cm Hg i.e. an exhaust pressure of 6 to 2.5 cm Hg (absolute) is aimed at. As high a vacuum in the condenser as possible is maintained for best working. In general high turbine capacity turbines maintain higher vacuum (73.5 cm Hg). Steam turbines used for power stations are condensing type. Surface condensers are used. Turbines with ratings up to 550 MW are available, while sizes up to 1000 MW are being designed and installed.
- Steam consumption, steam flow at any load
$$= \text{No load flow} + \left[\text{load} \times \frac{\text{Full load flow} - \text{No load flow}}{\text{Full load flow}} \right]$$

- Steam flow at no-load is 20-25% of the full load steam flow for small steam turbines while for large stations the corresponding figure is 3 to 10%.
- As a rough idea the steam consumption of large steam turbines is about 4 kg/kWh (steam pressure atleast 42 kg. per cm² at a temperature of 440°C absolute pressure at exhaust 5 to 9.5 cm Hg)
- A typical approximate heat balance sheet for a large turbine and surface Condenser taken together is as follows:

	Percent
Work done or thermal efficiency	28
Friction and Windage loss	0.1
Heat to circulating water	65
Heat in Condensate to be returned to boiler	0.6
	<u>100 %</u>

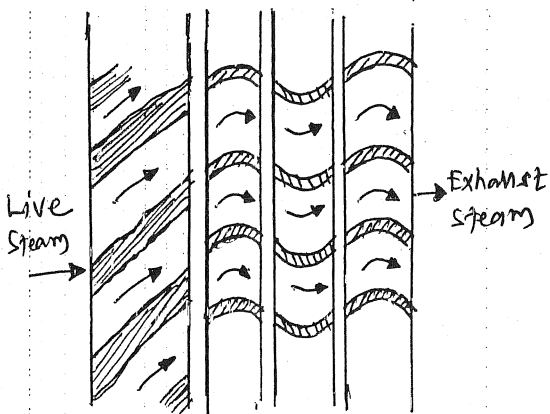
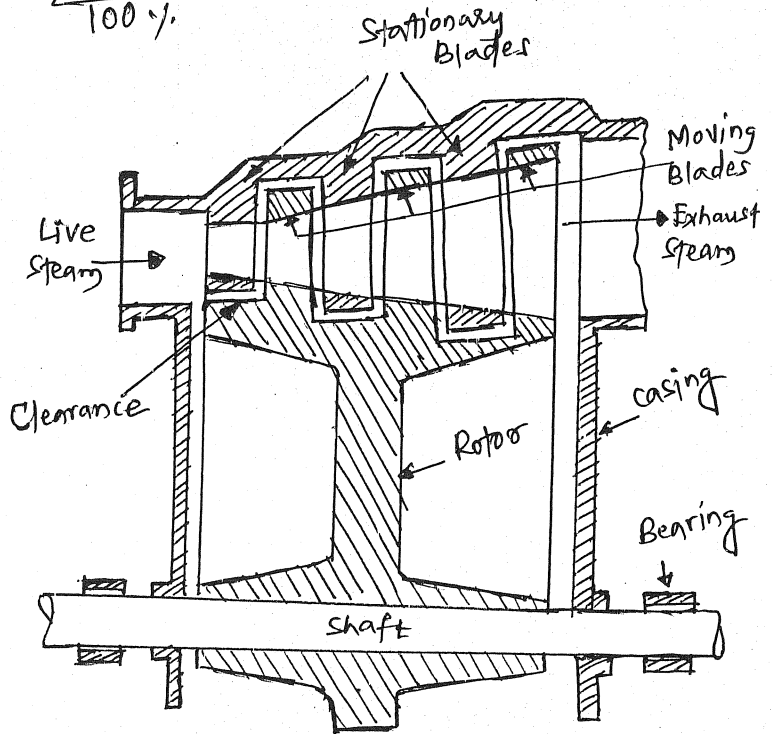
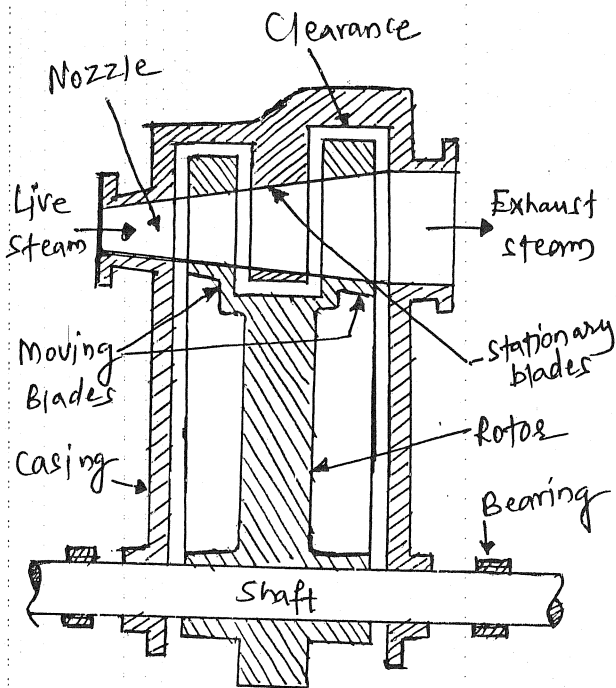

fig 3a. An Impulse turbine

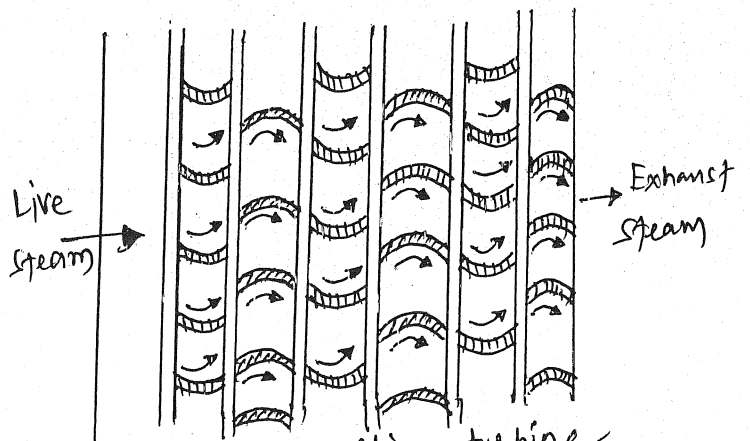

fig 3b. A reaction turbine

* Fuels and Fuel handling :

Fuels : Fuels may be classified as solid, liquid and gaseous and as natural or prepared. Fuel normally used in a thermal station is coal, oil or gas. Gaseous fuel is rarely economical except in special circumstances where it may be available very cheaply on site. Oil also is used only where it is plentiful and cheap. Coal is the fuel used most commonly in a thermal station (steam power station).

— Coal occurs naturally in seams and is the result of decay of vegetable matter accumulated in the earth millions of years ago having got transformed by the action of pressure and heat. As mined raw coal usually contains impurities such as pieces of slate etc. with the result that some amount of processing is required at the colliery before it can be shipped.

— Analysis of coal : In order to find the commercial value of coal two tests are performed. The commonly used tests are proximate and ultimate analysis.

proximate analysis : of coal gives good indication about heating & burning properties of coal. The test gives the composition of coal in respect of moisture, volatile matter, ash and fixed carbon.

Ultimate analysis : is a test that enables us to know the chemical composition of coal with respect to elements like carbon, hydrogen, oxygen, sulphur, nitrogen and ash. Nevertheless the chemical composition is very useful in combustion calculations and in finding the composition of flue gases. For the most purposes the proximate analysis is quite sufficient.

— Classification of coals : Coals are classified in increased order of heat value in the following : peat, lignite, bituminous, semi-bituminous, semi-anthracite & anthracite. Anthracite is the fully transformed coal of the best type while peat is the first stage of this transformation. The other varieties represent intermediate stages.

— Indian Coals : In general these coals have high ash content and the ash is finally disseminated through the coal so that cleaning of coal is a difficult and costly process. Washing of coal to reduce the ash content is necessary to obtain low ash metallurgical coal. Average ash content in Indian coal is as high as 20% and ash content of middlings at coal washeries lie between 30 and 40%. Recent Indian power plants in India are generally designed to use pulverised coal, as in that form of coal thermal efficiency may be as high as 90%.

- Liquid fuels: Oil can be used in a boiler furnace to generate steam, oil (alcohol, petroleum etc) used as a fuel. It offers a number of advantages. However the great disadvantage of liquid fuels is that the heat produced is costly as compared with coal or gas. Moreover, in a country like India where natural resources of oil are in short supply application of oils for power production is limited. Further as the fuel oil contains more percentage of hydrogen as compared to coal the moisture carried by the gas per kg of fuel burned is considerably more. This results in lower overall combustion efficiency of the plant as compared to the coal burning.
- Gaseous fuels: These fuels are broadly divided into natural or manufactured. Natural gas comes out of gas wells and petroleum wells. It contains 60 to 95% of methane and with small amounts of other hydrocarbons. It is piped in large volumes to distances of hundreds of kilometers in steel pipes having large diameters and at pressures of about 60 kg/cm^2 . The cost of such transmission is often high. Gaseous fuels possess all the advantages of oil fuels except for ease of storage. The major limitation of using natural gas as fuel is that the power plant must be located near the natural gas field otherwise cost of transportation will be high.
- Cost of transportation of fuel is an important consideration in selecting the fuel for a thermal power plant (steam power plant).

Fuel Handling

- Majority of the thermal (steam) power plants all over the world use coal as fuel. Therefore when dealing with the subject of fuel handling we restrict our discussion only to coal.
- In a thermal power station half of the total station operating cost is on account of coal and therefore problems of coal handling for a thermal power station require careful consideration.
- Requirements of a good coal handling plant are: it should be reliable, sound, simple requiring a minimum of operatives and minimum of maintenance. Besides the plant should be able to deliver the required quantity of coal at destination during peak periods. In essence, the function of coal handling system is to move coal from a receiving point to the firing equipment. The simplicity (or complexity) of the plant depends upon the way in which coal is received, orientation of the plant, desired capacity and flexibility of the arrangement. In order to satisfy a variety of conditions & meet several requirements an extensive array of mechanized handling devices may be combined in almost innumerable ways are usually available.
- While no coal handling system can be considered typical. Fig 4 shows various stages in coal handling. However it has to be remembered that it is not necessary that the flow chart may be followed as such in all the plants.

Depending upon the type of the plant intermediate steps may be eliminated or rearranged.

— Delivery of Coal : Coal may be delivered by sea or river, rail or road. Selection of proper method of coal supply from the coal mines to the power station depends upon the system capacity in tonnes per hour, location of the plant with respect to rail or water facilities available and location of available outside storage and overhead coal bunkers.

— Unloading : In unloading the choice of equipment will depend on how the coal is received.

— Preparation : Preparation of coal before feeding to the combustion chamber becomes necessary only if unsized coal is brought to the site and sizing is desirable for purposes of storage and firing. A coal-preparation plant may include the following.

- (a) Crushers (b) Sizers (c) Dryers (d) Magnetic Separators

— Transfer : This means carrying coal from unloading point to the storage site from where it is discharged to the firing equipment. It may require one or more than one equipment depending on local conditions. Equipment used for this purpose may be one or more of the following.

- (i) Belt conveyers
- (ii) Screw conveyers
- (iii) Bucket elevators
- (iv) Grab bucket conveyers
- (v) Skip hoists
- (vi) Flight conveyers.

— Outdoor (dead) storage : Storage of coal is essential for two reasons : First is that it is an insurance against complete shut-down of a power plant which may arise from failure of normal coal delivery. (Eventualities like strikes in coal mines, failure of transport system, general shortage of coal etc. are taken care of by a proper storage system). Second reason for storage of coal is that advantage can be taken of seasonal market conditions. This means that when prices are low coal can be purchased/stored for future use. However, there are a number of factors such as risk of spontaneous combustion, possibility of deterioration of coal during storage, interest on account of blocked capital, cost of insurance, cost of handling coal because of storage etc. which storage of coal undesirable. Amount of coal to be stored depends on available space for storage, transportation facilities, amount of coal that will weather away & nearness of the power plant to the coal mines.

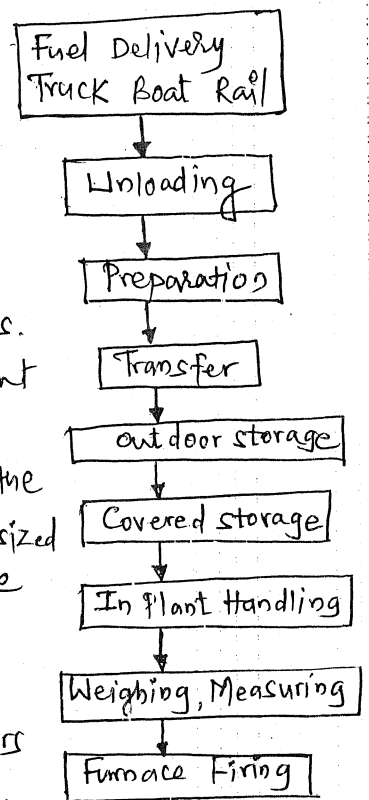

Fig 4 Various steps in coal handling

The usual practice is to store coal required for one month of operation of power station in case it is situated at a comparatively longer distance from the collieries whereas coal needed for about 15 days is stored in case of powerstations situated near to collieries. Storage of coal for longer periods is not advantageous because, as state above, it blocks the capital and results in deterioration of the quantity of coal. Coal received at the power station is stored in dead storage in the form of piles laid directly on the ground.

- Indoor (Live) storage : Such a storage constitutes coal requirements of the plant for a day. The live storage can be provided with bunkers and coal bins.

- Inplant handling : This refers to handling of coal between the final storage to the firing equipment. In case of simple stoker firing only chutes may be required to feed the coal from storage bunkers to firing units. In addition to this gates and valves may be included in the system to control the flow according to load on the plant. The pulverised fuel firing system would require equipments such as chutes, pulverising mills, feeders, weighing and many others for inplant handling.

(Equipments used for inplant handling are the same as used for coal transfer)

- Coal weighing : As stated earlier, cost of fuel is the major running cost of the plant. It is therefore very necessary to weigh coal at unloading point and also that used as feed to individual boilers. A correct measurement of coal enables one to have an idea of total quantity of coal delivered at the site and also whether or not proper quantity of has been burned as per load on the plant.

(a) weigh bridge (b) Belt scale (c) Automatic recording system.

* Fuel Combustion and Combustion equipment :

Fuel is burned in a confined space called furnace. An efficient - Combustion of fuel is essential for economical working of powerplant. In case of firing unpuverised coal in Combustion furnaces two general methods, namely hand firing and stoker (or mechanical) firing are available. (A stoker is a fuel firing device which receives fuel by gravity, carries it into the furnace for combustion & after - Combustion discharges the ash at the appropriate point). In the case of pulverised coal two delivery systems, namely unit system & Central (or storage) system, are available.

Hand firing : This method of firing is simple, requiring no capital investment. This method can however be used only in small installations because uniformity of combustion is difficult to control in this type of firing. Further adjustments for the supply of air are to be made every time coal is fed to furnace.

stoker firing : In this method of firing coal is carried into the furnace for combustion and ash formed after combustion is discharged at appropriate point. stokers are designed for meeting specific requirements of fuels. It is possible to burn caking, non-caking or non-clinkering fuels. While some stokers can work with natural draught others need mechanical draught.

There are two main classes of stokers. These are overfeed and underfeed. The two differ in the manner of feeding of coal above or below the level at which primary air is admitted in the furnace. These are further classified as shown in fig 5.

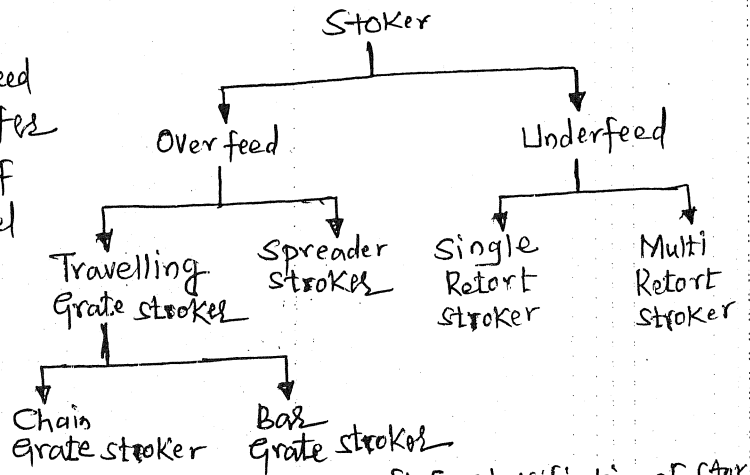

fig 5. Classification of stokers

The distinction between overfeed and underfeed stokers will be clear from a reference to figures 6a and fig 6b below. In the case of overfeed stoker coal is fed on to the grate above the point of admission of air. In the case of an underfeed stoker fuel is fed from underneath the fire and works gradually upwards, primary air being supplied into the bed just below the level at which combustion takes place. Bituminous and semi-bituminous coals with small ash content and fusing temperature above 1300°C (caking or non-caking) can be burned very efficiently in these stokers.

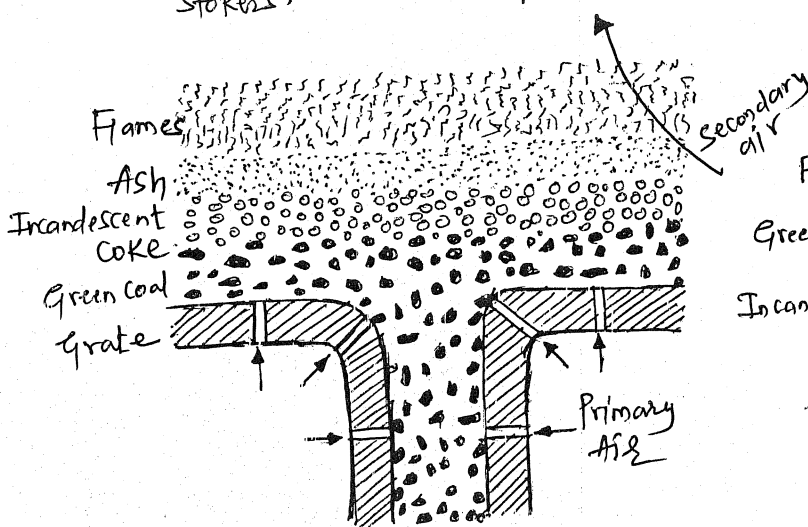

Fig 6a
An over feed stoker

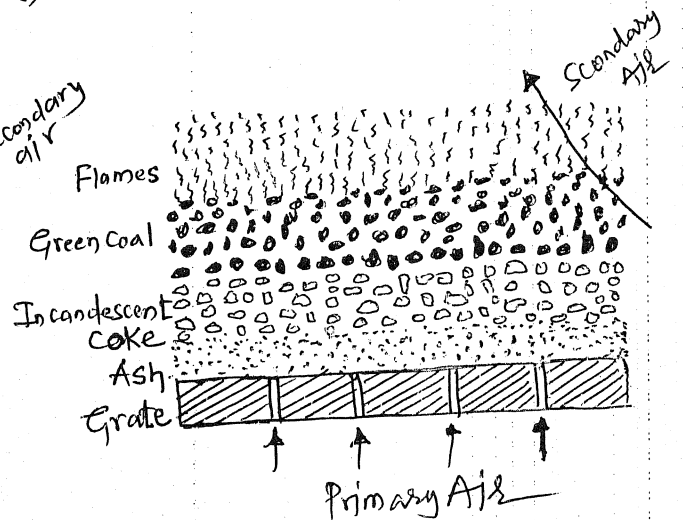

Fig 6b
An underfeed stoker

Pulverised Fuel system : Two delivery systems of pulverised fuel are in common use. These are - the unit systems and central (or bin) system. In the unit systems each furnace is fired by one (or more) unit - pulverizers connected to its burners while in the central system fuel is pulverized in a central plant and then distributed to each furnace with the help of high pressure air current. Present day practice - favours the unit system due to facility in control. In each type the fuel processing equipment consists of crushers, magnetic separators, driers, pulverising mills, storage bins, conveyers and feeders.

Coal pulverising Mills : Essential requirements of such mills are drying of coal, grinding, separation of ~~practi~~ particles of desired size, forming proper fuel-air ratio and suitable controls for all these operations.

* Coal Burners : Pulverised fuel Burners. In its simplest form a burner incorporates an arrangement for supplying correct amount of fuel and air to the furnace. (Depending upon the type of fuel handled by a burner it may be known as a liquid fuel burner, gas fuel burner, pulverised fuel burner etc).

Pulverised fuel burners may be classified as :

- i) Long Flame Burners
- ii) Turbulent Burners
- iii) Tangential Burners
- iv) Cyclone Burners.

* Fluidized-Bed Combustion :

Direct combustion of coal is best accomplished by fluidized bed combustion (FBC). If compressed gas is passed upward through a bed of inert particles at a sufficient velocity to overcome gravity, each particle will float on the gas stream in a boiling turbulent mass. This is known as fluidized bed. Coal particles are added to the inert mass and may constitute only 10% of the mass and thus cannot adhere to each other or agglomerate. Instead of inert particles such as ash and sand, lime stone or dolomite is ~~not~~ widely used in proper proportion to combine with sulphur in coal and produce solid surface sulphate particles. The production of nitrogen oxides (NO_x) is also reduced greatly at lower combustion temperatures. Thus it has advantages : direct removal of sulphur during combustion; low NO_x emission, ability to burn a variety of fuels, and smaller size.

* Combustion Control :

Automatic Combustion control. When the load on a generator changes there is a corresponding change in demand for steam. Automatic

Control regulates and automatically changes in demand of steam & also effects quick and suitable changes in other variables so as to maintain constant steam pressure and proper combustion conditions. It is obvious that an automatic combustion control system has to maintain constant steam pressure under all load conditions. The parameters to be controlled with variations in load are steam, water, fuel and air etc. (An automatic control saves manual labour.)

- In practice combustion control devices based upon changes in steam pressure are most popular. (Any one or a combination of - fluctuation in steam pressure, rate of steam flow, furnace draught can be used).

* Ash handling and Dust collection

In a large power station ash accounts for 10 to 20% of the coal burnt. For a large rating of the power station a huge quantity of ash is therefore to be disposed of. Handling of ash is a problem because ash coming out of the furnace is (i) too hot (ii) dusty (therefore irritating to handle) and (iii) it produces poisonous gases and corrosive acids when mixed with water.

- Ash handling systems: There are four groups into which modern ash handling systems may be divided. These are
 - (i) Mechanical handling system
 - (ii) Hydraulic system
 - (iii) Pneumatic system
 - (iv) Steam jet system.
- Dust collection: Dust may be defined as the solid matter in flue gases which is more than 0.001 mm and less than 0.1 mm in diameter. Quantity of dust in flue gases largely depends upon the method of fuel firing. Dust nuisance is greatest with pulverised fuel and spreader stoker firing systems and is much less with underfeed stoker systems. To give an idea of the problem a 100 MW capacity power station using pulverised coal as fuel will discharge as much as ~~five~~ 150 tonnes of ash per day with the exhaust gases if due care is not taken to remove the dust particles from the exhaust gases.
- Major emissions from thermal power stations are fly-ash, carbon ash (known as cinder), smoke, dust and irritating vapours like CO, SO₂ & nitrogen oxides. These emissions are objectionable if the content exceeds a particular limit.
- Indian coals contain a very high percentage (around 40%) of ash. With pulverised form of coal firing up to 80% of ash in the coal may be carried out with exhaust gases in a very fine form. Another difficulty with Indian coals is the higher percentage of sulphur. Sulphur emitted to the atmosphere is the form of sulphur dioxide is highly objectionable on account of its bad effects on human beings.

- In view of above cleaning of flue gases for power stations using Indian coal as fuel is very necessary. However cleaning of gases is a difficult problem because of (a) large percentage of silica in the ash and (b) fineness of typical fly-ash.
- Gas cleaning devices make use of certain physical/electrical properties of the particulate matter of the gas stream. Basically gas cleaning devices (or dust collectors) may be classified into mechanical & electrical (electrostatic precipitators). Mechanical dust collectors have efficiency increasing with load while the efficiency of electrostatic precipitators falls as load increases. A combination of the two collectors gives a constant efficiency characteristics and is often used. The mechanical unit serves to remove heavier dust particles and the electrostatic controller eliminates finer particles.

* Draught Systems :

- The purpose of draught is to supply an adequate amount of air for combustion and bring it into intimate contact with the fuel. Problems associated with draught includes introduction of proper quantity of air at the proper place and removal of products of combustion.
- Draught is defined as the difference between absolute gas pressure at any point in a gas flow passage and the ambient (same elevation) atmospheric pressure. Draught is achieved by small pressure difference which causes the flow of air or gas to take place. It is measured in millimeters (mm) of water. (Accordingly draught can be produced by means of chimney, fan, steam or air jet or a combination of these.) [When the draught is with the help of chimney only, it is known as natural draught] and th (when the draught is produced by any other means except chimney it is known as mechanical or artificial draught.) We may therefore, say that when the draught is produced by action of chimney alone it is called natural draught remove this (no fan is needed in this case). (When the draught is produced by drawing out gases from the chimney with the help of a fan placed at the chimney base it is called an Induced draught). (Similarly when the draught is produced by forcing air through the fuel bed with the help of a fan it is called a forced draught).
- Artificial draught may be classified into mechanical draught & steam jet draught. (Steam jet draught is preferred in small installations & locomotives while mechanical draught is preferred for central power stations).

* Feed Water :

Natural water cannot be used as such for steam generation as it contains solid, liquid and gaseous impurities, which damage the blades of turbine. This water as such cannot, therefore, be used for generation of steam in the boilers. (Impurities in raw water have to be removed before it use in boilers.) Even though main Condensate returns to the boiler as feed water make-up water is still required to replace the loss of water due to blow-down, leakage etc. In this cycle. Notwithstanding the fact that the amount of make-up water required is only about 1% the total make-up water required for 100 MW plant will be of the order of 25-30 tonnes per hour. As such, in general, it becomes necessary to have a separate water softening plant.

Different impurities in natural (raw) water as follows :

- (i) Undissolved and suspended solid materials (turbidity & sediment which includes coarse particles like mud, sediment, sand etc. & sodium & potassium salts etc. Sometimes some iron, manganese or silica are also present)
 - (ii) Dissolved salts and minerals. (These include carbonates, bicarbonates, sulphates & chlorides of calcium & magnesium)
 - (iii) Dissolved gases such as carbon dioxide and oxygen
 - (iv) Other materials (such as oil, acid) either in mixed or unmixed forms.
- Operational troubles are caused due to impurities in feed water. These are
- (i) Scale formation
 - (ii) Corrosion
 - (iii) Priming, foaming & carry over
 - (iv) Caustic embrittlement.

- Different methods of feed water treatment : The basic purpose of water treatment is to remove suspended solids, dissolved solids & dissolved gases from water before it is supplied to boiler. These are three main groups of water treatment namely.

- (i) Mechanical treatment
 - (ii) Thermal treatment
 - (iii) Chemical treatment.
- Evaporators : These are used for supplying pure water as make-up feed water in the boilers. In an evaporator raw water is evaporated by using extracted steam. It is then condensed to give distilled & pure feed water. There are two main classes of evaporators. These are film type & submerged type.

Feed water heaters : These heaters are used to heat feed water before it is supplied to the boiler. There are two types of heaters, namely contact or open & surface or closed heaters.

* Steam Power plant controls & Plant auxiliaries.

- A number of controls at the boiler, turbine and generator unit are provided in a steam station in order to maintain the best conditions at different loads.
- We have already considered automatic combustion control for maintaining the best boiler efficiency and seen how this control keeps fuel/air ratio constant while the load changes.
- Turbine governing is effected in either of two ways. In the case of small turbine it is throttling at a single inlet valve. For a large turbine a number of nozzles at the steam inlet are provided; these nozzles gradually open one after the other as the load on the turbine is increased. Maintaining proper vacuum in the condenser enough circulating water, a number of pumps, oil pressure for control of circuits, steam bleeding if any and the heaters & feed-water control are other equipments of the turbine.
- At the generator an increase in load will result in a reduction in frequency for an isolated generator. However, if the generator is connected to infinite busbars (i.e. large number of generators working in parallel) the load taken by the generators can be adjusted by adjusting the speed of the turbine, for that case the frequency remains constant and the change of excitation changes the power factor of the generators.
- In general centralised control is adopted for modern steam stations, the boiler and turbine control being at one place in the turbine room and the generator and feeder controls in the control room; in some cases all controls are centralized at one place in the control room.
- Most of the controls are automatic. A number of annunciators & indicating instruments help in controlling the operation of the steam station very effectively.

Plant auxiliaries

- Boiler make-up water treatment plant and storage since there is a continuous withdrawal of steam and continuous return of condensate to the boiler, losses due to blow down and leakage have to be made up to maintain a desired water level in the boiler steam drum. For this continuous make-up water is added to the boiler system. Hardness of water is removed by a water demineralising treatment plant (DM), as hardness in the make-up water to the boiler will form deposits on the tube water surfaces which would lead to overheating & failure of tubes.
(A storage tank is installed from which DM water is continuously withdrawn for boiler make-up.) The storage tank for DM water is made from materials not affected by corrosive water. The piping & valves are generally of stainless steel.

Fuel preparation system: In coal fired power stations, the raw feed coal from the coal storage is first crushed into small pieces and then conveyed to the coal feed hoppers at the boilers. The coal is next pulverised into a very fine powder. The pulverisers may be ball mills, rotating drum grinders or other type of grinders.

Barring gear: (or turning gear) is the mechanism provided to rotate the turbine generator shaft at a very low speed after unit stoppages. off system: Once the unit is tripped (i.e. the steam inlet valve is closed), the turbine coasts down towards standstill. When it stops completely, there is a tendency for the turbine shaft to deflect or bend if allowed to remain in one position too long. This is because the heat inside the turbine casing tends to concentrate in the top half of the casing, making the top half portion of the shaft hotter than bottom half. The shaft therefore could warp or bend by millionths of inches.

Oil system: An auxiliary oil system pump is used to supply oil at the start-up of the steam turbine generator. It supplies the hydraulic oil system required for steam turbine's main inlet steam stop valve, the governing control valves, the bearing and seal oil systems, the relevant hydraulic relays and other mechanisms.

Generator cooling: While small generator may be cooled by air drawn through filters at the inlet, larger units generally require special cooling arrangements. Hydrogen gas cooling, an oil-sealed cooling, is used because it has the highest known heat transfer coefficient of any gas and for its low viscosity which reduces windage losses.

Generator high voltage system: The generator voltage for modern utility connected generators ranges from 11kV in smaller units to 20kV in larger units. The generator high-voltage leads are normally large aluminium channels are connected to step-up transformers for connecting to a high-voltage electrical substation (usually in the range of 115kV to 765kV) for further transmission by the local power grid.

Monitoring & alarm system: The plant is provided with monitors & alarm systems that alert the plant operators when certain operating parameters are seriously deviating from their normal range.

Battery-supplied emergency lighting & communication: A central battery system consisting of lead acid cells units is provided to supply emergency electric power, when needed, to essential items, such as the power plant's control systems, communication systems, generator hydrogen seal system, turbine oil pumps, & emergency lighting. This is essential for safe, damage free shutdown of the units in an emergency situation.

Circulating water system: To dissipate thermal load of main turbine exhaust steam condensate from gland steam condensers, & condensate from low pressure heaters by providing a continuous supply of cooling water to the main condensers thereby leading to condensation.

8, 9, 10, 11, 12, 13, 14, 15, 16, 17, 18, 19, 20, 21, 22, 23, 24, 25, 26, 27, 28, 29, 30, 31, 32, 33, 34, 35, 36, 37, 38, 39, 40, 41, 42, 43, 44, 45, 46, 47, 48, 49, 50, 51, 52, 53, 54, 55, 56, 57, 58, 59, 60, 61, 62, 63, 64, 65, 66, 67, 68, 69, 70, 71, 72, 73, 74, 75, 76, 77, 78, 79, 80, 81, 82, 83, 84, 85, 86, 87, 88, 89, 90, 91, 92, 93, 94, 95, 96, 97, 98, 99, 100

Diesel Power Plant

- In diesel power plant a diesel engine is used as a prime mover for the power generation. The diesel engine uses a diesel as fuel. The heat energy obtained by the ~~combustion~~ combustion of the diesel is converted into mechanical energy. An alternator or a d.c. generator mechanically coupled to the diesel engine which converts the mechanical energy into electrical energy.
- These ~~are~~ diesel plants are more efficient than any other heat engine of comparable size. (These plants are cheap by way of initial cost, can be started and stopped quickly and can burn a wide range of fuels.) A diesel plant does not require any warming period; It need not be kept running for a long time before picking up load. As a result there are no standby losses. Another advantage of such a plant is that it does not need large amount of water for cooling. A diesel station can be commissioned in a much shorter time compared with a hydro, steam or nuclear power station.
- Although steam power stations & hydro-electric plants are invariably used to generate bulk power at cheaper cost, yet diesel power stations are finding favour at places where demand of power is less, sufficient quantity of coal and water is not available & the transportation facilities are inadequate. These plants are ^{also} used as standby sets for continuity of supply to important points such as hospitals, radio stations, cinema houses & telephone exchanges.

* Merits of diesel power plants

Diesel power plants offer several advantages as follows.

- (i) The capital cost per kW is low.
- (ii) The design and installation are simple & cheap.
- (iii) It occupies less space as the number and size of the auxiliaries is small.
- (iv) These can be easily procured, installed & commissioned in less time.
- (v) Starting time & stopping time are very less. Thus can be put into service and taken out quickly.
- (vi) These have the good efficiency (approximately 40-45%), which is higher than thermal power plants.
- (vii) Small diesel generators can be portable & can be put near any load requirement. However a big size diesel power plant can be located near load centres as it requires less space.
- (viii) These power plants are free from ash & require less water for cooling system.
- (ix) The operation is simpler, & req lesser operating & supervising staff is needed than a thermal power plant.

* Demerits of diesel power plant :

The diesel power plants have several disadvantages as well. They are

- (i) The operating cost of it is very high as diesel is more costly than coal.
- (ii) The size of diesel unit is limited & very large capacity is not possible with these prime movers.
- (iii) Their repair and maintenance costs are high.
- (iv) The useful life is very less (approximately 5-10 years)
- (v) They have limited overload capacity.
- (vi) The noise & air pollution is more.

* Selection of site for diesel power station :

The following factors are to be considered while selecting site for diesel power station.

- (i) Distance from load centre
- (ii) Availability of land and water
- (iii) Foundations
- (iv) Transport of fuel
- (v) Local conditions
- (vi) Neighbourhood noise & nuisance.

* Elements of diesel power plant

The essential components of a Diesel electric plant are :

- (i) Engine
- (ii) Engine fuel system
- (iii) Engine air intake system
- (iv) Engine exhaust system
- (v) Engine cooling system.
- (vi) Engine lubricating system
- (vii) Engine starting system

(i) Engine : This is the main component of the plant which develops power. Generally engine is coupled directly to the generator.

(ii) Engine fuel system : This includes the fuel storage tanks, fuel transfer pumps, strainers, heaters & connecting pipe work. Fuel transfer pumps are required to transfer fuel from delivery point to storage tanks and from storage tanks to engine. Strainers are needed to ensure clean fuel. Heaters for oil may be required especially during winter.

(iii) Engine air intake system : This includes air filters, ducts & supercharger (an integral part of engine). The purpose of air filters is to remove dust from the air to be supplied to the engine.

The system supplies the required quantity of air for combustion. The supercharger increases the pressure of air supplied to the engine so that it could develop an increased power output. - Superchargers are generally driven by the engines.

(iv) Engine Exhaust system : This includes silencers & connecting ducts. As the temperature of exhaust gases is sufficiently high, heat of these gases is utilised in heating oil or air supplied to the engine. The silencer reduces the noise level.

(v) Engine Cooling system : This includes coolant pumps, cooling towers or spray ponds, water treatment or filtration plant & connecting pipe work. The purpose of cooling system is to carry heat from engine cylinder to keep the temperature of cylinder within safe limits. The pump circulates water through cylinder & head jackets to carry away heat. Thus the simplest cooling system would need only a water source, a pump and a place for disposal of hot water. Usually, however, the same water is recirculated by cooling it in devices such as radiators, evaporative coolers, cooling towers, spray ponds etc.

(vi) Engine Lubrication system : This includes lubricating oil pumps, oil tanks, coolers, purifiers and connecting pipe work. The function of the lubrication system is to reduce the friction of moving parts & reduce the wear and tear of the engine parts.

(vii) Engine starting system : This includes storage battery, compressed air tanks, self starters etc. The function of the starting system is to start the engine from cold by supplying compressed air. The system enables the engine to rotate initially while starting until the firing starts and the units run on its own power.

(viii) Alternator : The alternators used in diesel power plants are of rotating field, salient pole construction, speed ranging from 24 to 1000 rpm (poles 28 to 6) & capacities ranging from 25 to 500 kVA at 0.8 pf lagging. Their output voltages are 440V in case of small machines & as high as 2200V in case of large machines. Voltage regulation is about 30%.

Gas Turbine Power Plant

- A generating station which employs gas turbine as the prime mover for the generation of electrical energy is known as a gas turbine power plant.
- In a gas turbine power plant air is used as the working fluid. The air is compressed by the compressor and is led to the combustion chamber where heat is added to air, thus raising its temperature. Heat is added to the compressed air either by burning fuel in the chamber or by the use of air heaters. The hot and high pressure air from the combustion chamber is then passed to the gas turbine where it expands and does the mechanical work. The gas turbine drives the alternator which converts mechanical energy into electrical energy. It may be mentioned here that compressor, gas turbine & the alternator are mounted on the same shaft so that a part of mechanical power of the turbine can be utilised for the operation of the compressor. Gas turbine power plants are being used as standby plants for hydro-electric stations, as a starting plant for driving auxiliaries in power plants etc.
- Gas turbine (GT) based technology is of great interest to the developing countries because it is the most efficient technology for converting fossil fuels into electricity and because of ongoing research and development to make it even more efficient. In addition gas turbine generates relatively low level of greenhouse gases (GHG) such as carbon dioxide. Finally, GT based technology has the flexibility to deal with the situations where natural gas is not readily available (a situation that frequently occurs in developing countries) because it can handle a wide variety of low calorific value & contaminated - contaminated fuels, the latter requiring a lot of care for their successful operation.

* Merits & Demerits of Gas turbine plant *

* (i) Merits of gas turbine plant :

- (i) Gas turbine system is compact & required less space compared to steam power plant of same capacity.
- (ii) It requires fewer auxiliaries & installation takes less time.
- (iii) There is no condenser maintenance.
- (iv) It requires a simple lubricating system, light foundation.
- (v) It can be easily controlled.
- (vi) It can be quickly started & as compared to steam power plant.
- (vii) The fuel consumption is low during the starting & shutting down.

- (viii) There is clean exhaust & there is no stack required.
- (ix) Due to fewer auxiliaries, the required personnel to run the plant are also less.
- (x) In the case of no run plant, personnel required are almost nil.
- (xi) Virtually, there is no water requirement.
- (xii) Gas-turbine plants have low weight/power ratio.
- (xiii) It is also economical to operate below a given power factor & thus saving of cost.
- (xiv) The capital cost is comparatively smaller than that of steam power plant.

* Demerits of Gas turbine power plant :

- (i) There is a problem for quick starting the unit. Because the external source ^{power} is required to start turbine & compressor has to be operated before the unit starts.
- (ii) Since lot of the power developed by the turbine is used in driving the compressor, the net output is low.
- (iii) The overall efficiency of gas turbine plant is low (about 30%) because exhaust gases from the turbine contain sufficient heat.
- (iv) The temperature of combustion chamber is quite high (2000°F) so that the life is comparatively reduced.

* selection of site :

Following are the factors to be considered for selection of site for Gas turbine power plant.

- (i) Distance from load centre
- (ii) Availability of land at reasonable rate
- (iii) Availability of fuel at reasonable rate.
- (iv) Availability of transportation facilities.
- (v) Distance from populated areas
- (vi) Type of land (land should be of high bearing capacity)

* Fuels for Gas turbines :

A wide variety of fuels from solid to gaseous can be used in gas turbine plants. The ideal fuel is of course natural gas but this is not always available. Natural gas is obtained from wells in oil fields. It is generally used for auxiliary power production within the oil fields. Blast furnace & producer gas can also be used for these plants.

✓

Liquid fuels of petroleum origin such as distillate oils or residual fuels (including oils, furnace oils, boiler fuel oils) are most commonly used for such plants. When using such fuels one has to be very careful that the fuel used possesses proper volatility, viscosity & calorific value. Also the fuel should be free from any content of moisture & suspended impurities that may clog the small passages of the nozzles & damage valves & plungers of the fuel pumps. Minerals like sodium, vanadium & calcium prove very harmful for the turbine blading as they build up deposits or corrode the blades. Distillate fuels burn with more ease than do residual fuels. Therefore when starting the unit from cold initially distillate fuels are fed into the combustor after which residual fuels may be fed. In cold climate it may be necessary to preheat residual fuels. Use of solid fuels (for example pulverised coal) in gas turbines presents a number of difficulties. In view of the difficulties involved even though the use of coal as fuel for closed cycle plant is universally accepted, its use in open cycle plant is not yet developed.

One further advantage of gas turbines is their fuel flexibility. They can be adapted to use almost any flammable gas or light distillate petroleum products such as gasoline (petrol), diesel & kerosene (paraffin) which happen to be available locally, though natural gas is most commonly used fuel. Crude and other heavy oils and can also be used to fuel gas turbines if they are first heated to reduce their viscosity to a level suitable for burning in the turbine combustion chambers.

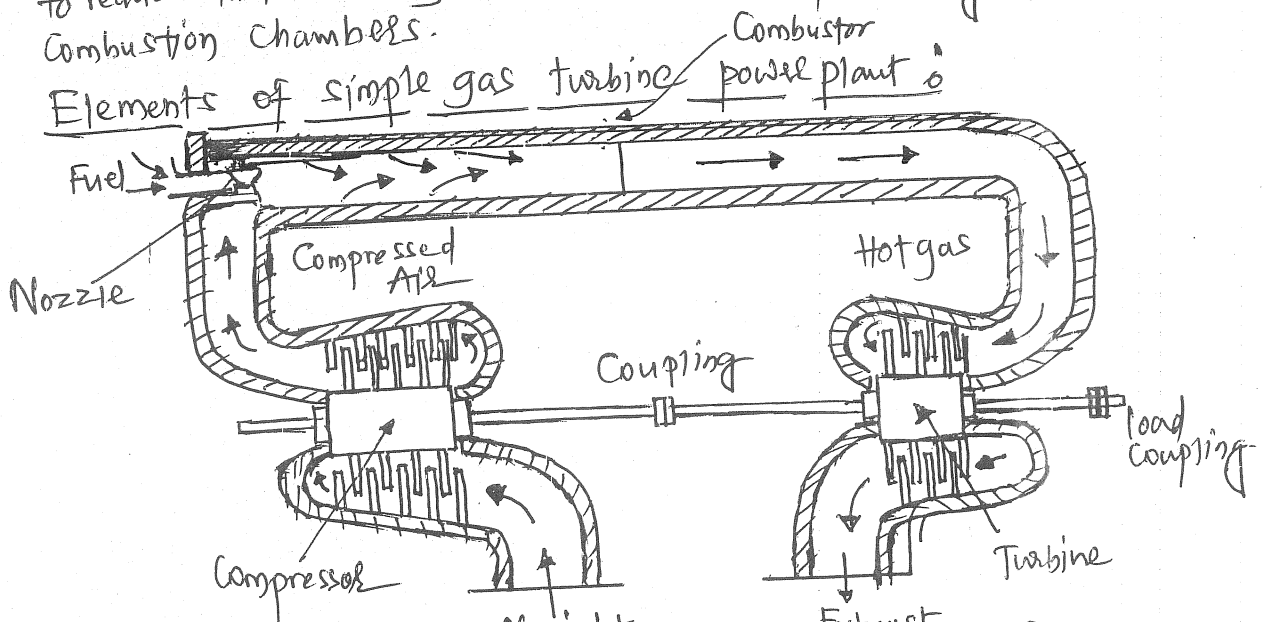

Fig 1. Arrangement of simple gas turbine plant.

A simple gas turbine plant consists of a Compressor, Combustion Chamber or Combustor & turbine. Besides these main components there may be auxiliaries such as starting device, fuel system, the duct system, auxiliary lubricating system etc. A simple gas turbine plant is shown in fig 1.

Compressor : The compressor used in the plant is generally of rotary type. The air at atmospheric pressure is drawn by the compressor via the filter which removes the dust from air. The rotary blades raise its pressure. The air at high pressure is available at the output of the compressor.

Combustion Chamber : The air at high pressure from the compressor is supplied to the combustion chamber via the generator. In the combustion chamber heat is added to the air by burning oil. The oil injected through the burner into the chamber at high pressure to ensure atomisation of oil & its proper mixing with air results in proper burning of mixture & chamber attains a very high temperature (about 3000°F). The combustion gases are suitably cooled to 1300°F to 1500°F then delivered to the gas turbine.

Gas turbine : The products of combustion comprising of a mixture of gases at high temperature & pressure are passed to the gas turbine. These gases while passing over the turbine blades expand and causing the turbine blades to rotate. The temperature of the exhaust gases from the turbine is about 900°F .

Alternator : The gas turbine is coupled to the alternator. It converts mechanical (rotary) energy into electrical energy. The output from the alternator is given to the bus-bars through transformer, circuit breaker & isolator.

Starting Motor : Before starting the turbine, compressor has to be started. For this purpose an electric motor is mounted on the same shaft of the turbine. The motor is energized from batteries. Once the unit starts, a part of mechanical power of the turbine drives the compressor & there is no need of motor then.

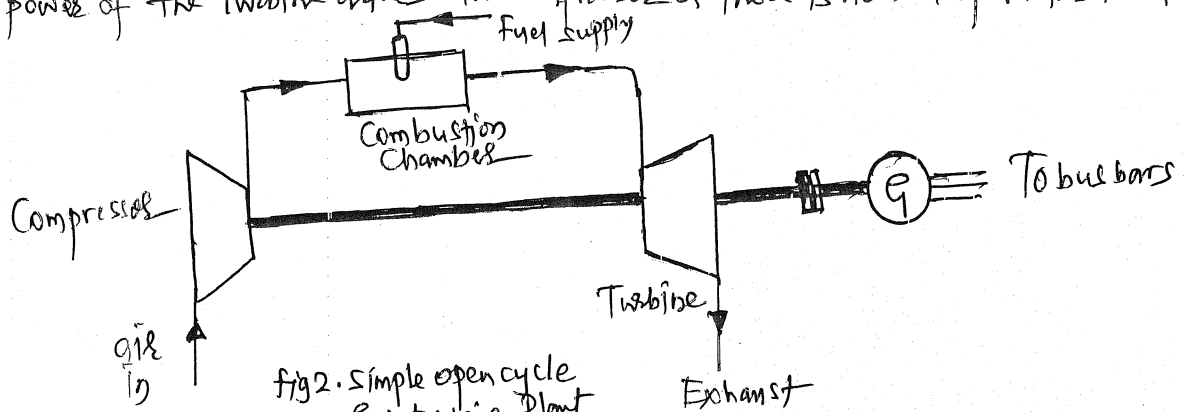

fig 2. Simple open cycle Gas turbine plant

* Methods of Improving Thermal efficiency of a simple gas power plant:

The efficiency of simple gas turbine is very low. There are three methods to increase the thermal efficiency of the cycle, where are: regeneration, reheating and intercooling.

Regeneration: Recovering waste heat from the high-temperature exhaust gases of a gas turbine is a means of improving the cycle efficiency. It is similar to the air preheater in the case of thermal power plants. The device used for extracting the heat from the heated gas is called regenerator or heat exchanger. These are either tabular or rotary plate type in construction. Fig 3a. below shows a line diagram of gas turbine with regenerator.

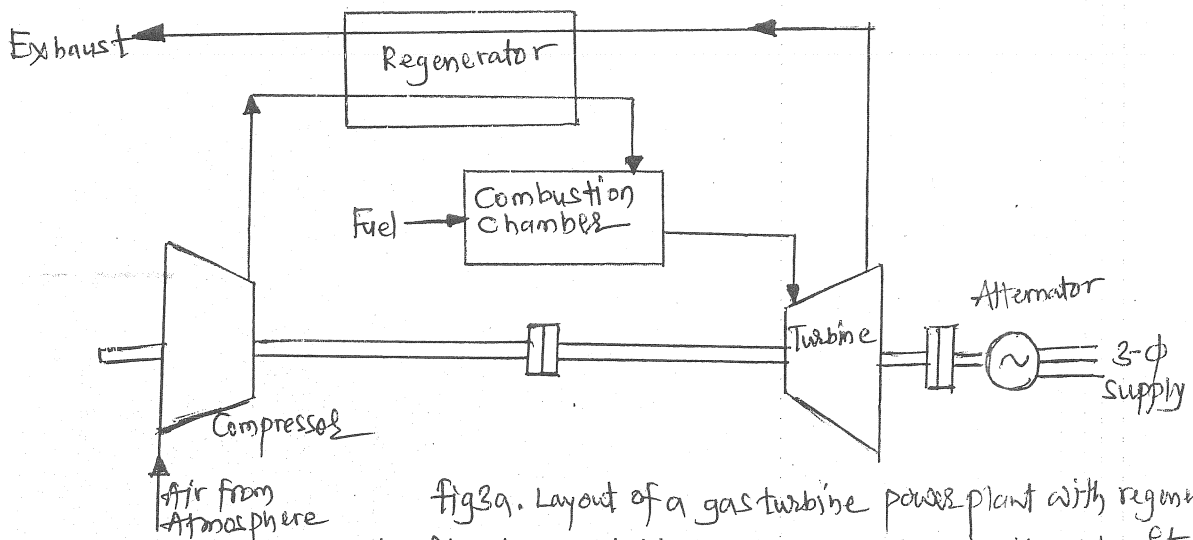

Fig 3a. Layout of a gas turbine power plant with regenerator.

It should be noted that with the addition of regenerator in the circuit there is no change in compressor & turbine work but the quantity of fuel supplied is substantially reduced (i.e. there is gain in heat recovery) as the temperature of the air entering the combustion chamber is increased. In order to improve heat transfer from the regenerator there are two choices: one is to increase the surface area & other is to increase the turbulence of flow. However, the first choice involves higher initial cost while the second results in an increased pressure drop. As such the design of regenerator is a compromise between the gain in heat recovery on the one hand & higher initial & operating cost on the other.

Reheating: Partially expanded high-temperature gas in turbine can be reheated so that it can be expanded further to produce additional work. There ^{may be} several stages of heating. If only one turbine is there, then there will be no use of reheating. In two-stage turbine, one reheater can be used, as shown in fig 3b. It improves the performance of the gas turbine, by improving the output from the turbine due to multiple heating. Reheater may in fact be taken as an additional combustor.

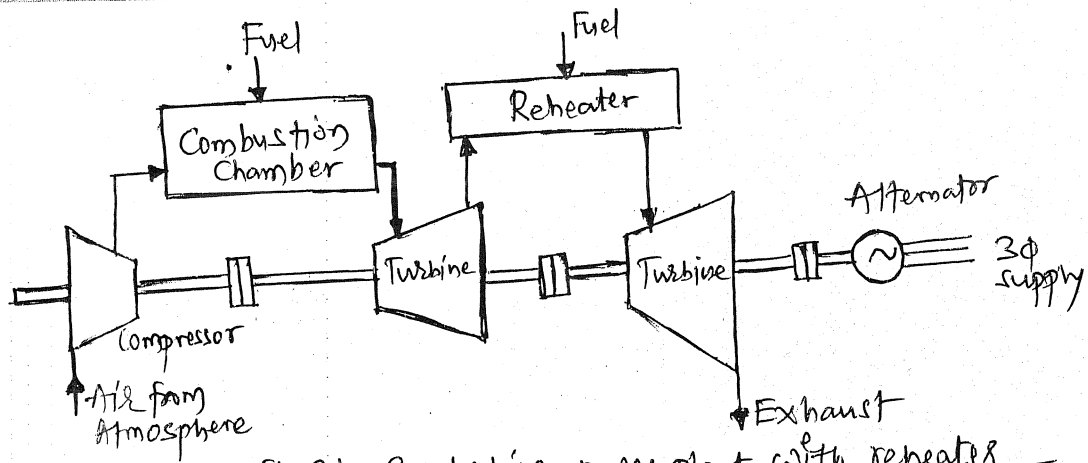

fig 3b. Gas turbine power plant with reheat

Intercooling : Compressor consumes very high energy & therefore two compressors are used with intercooling, which acts as a heat exchanger, as shown in fig 3c. below. The power required to run the compressor could be reduced because reduction in the volume of air-cooled. The number of stages of compressors are decided based on the cost & energy saving. Intercooling results in the enhancement of thermal efficiency, air rate and work ratio. Therefore overall size of the power plant is reduced for same capacity. Normally, air or water is used to cool the compressor. Intercooling means cooling the air after it has been partially compressed.

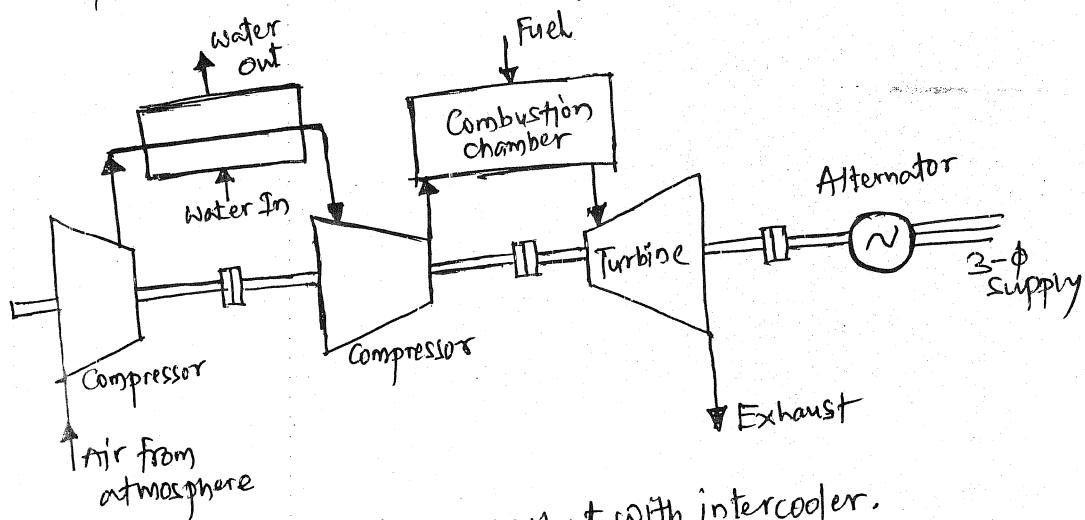

fig 3c. Gas turbine power plant with intercooler.

— We may conclude that our discussion by saying that the thermal efficiency of a simple gas turbine plant can be increased by using one or more of the methods described above.

These are based on,

- (a) Reducing the work required to run the compressor (intercooling).
- (b) Reducing the heat (fuel) supplied to the combustor (regeneration, reheat).

In an actual power plant intercooling, regeneration & reheat may all be used to increase the overall thermal efficiency of the plant & specific power output. fig 3d. shows such an arrangement.

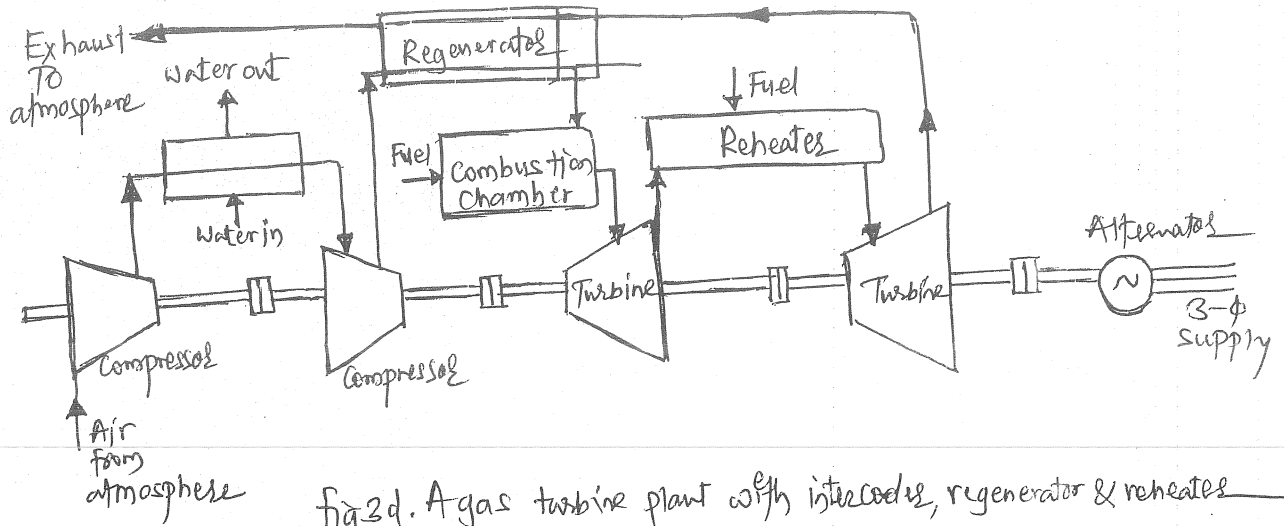

fig 3d. A gas turbine plant with intercooler, regenerator & reheater

* Closed cycle gas turbine power plant

In closed cycle gas turbine as shown in fig 4 below, the heat to the working fluid medium (air or any suitable gas) is given without directly burning the fuel in the medium & the same working fluid is used again and again in the cycle. In this working fluid is compressed in the compressor and is fed into the heater where it is heated up to the temperature of turbine inlet. This fluid is then expanded in the turbine & the exhaust is cooled to the original temperature in the re-cooler (pre-cooler). It then enters the compressor to begin the next cycle. The heater burns any suitable fuel & provides the heat for heating the working medium. In fact the combustor is similar to an ordinary boiler furnace working at the atmospheric pressure and discharging the gaseous products to the atmosphere. The pre-cooler (re-cooler) corresponds to the condenser of a steam plant. The air heater corresponds to the water heater of the steam plant. Closed cycle gas turbine plants are not yet used for the generation of electricity due to large size of required heat exchangers.

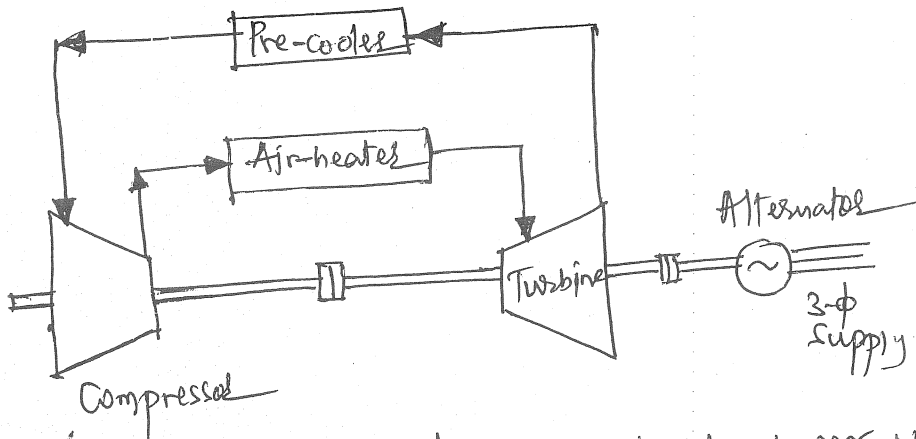

fig 4. Closed cycle gas turbine power plant.

* Comparison of gas turbine power plant with steam & diesel power plants.

SN	Item	Steam Power Plant	Diesel power plant	Gas turbine Power Plant
1.	Site	Such plants are located at a place where ample supply of water & coal is available. transport facilities are adequate	such plants can be located at any place because they require less space & small quantity of water	
2.	Initial cost	Initial cost is lower than that of hydro electric & nuclear power plants	Initial cost less for compared to other power plants	
3.	Running Cost	Higher than that of diesel & gas turbine plants hydro & nuclear plants because of requirement of huge amount of coal	Highest among all plants because of high price of diesel.	
4.	Limits of source of power	Coal is the source of power which has limited reserves all over the world	Diesel is the source of power which is not available in huge quantities due to limited reserves.	
5.	Cost of fuel transportation	Maximum because huge amount of coal is transported to the plant site	Higher than hydro & nuclear power plant	
6.	Cleanliness & simplicity	Least clean as atmosphere is polluted due to smoke	More clean than steam & gas power plants.	
7.	Overall efficiency	Least efficient. overall efficiency is about 25%.	More efficient than steam power plant. Efficiency is about 35%.	30, 31, 7, 12, 24, 27, 28, 38, 43, 45, 64, 66, 68,
8.	Starting	Requires a lot of time for starting	can be started quickly	30, 31, 2, 6, 7, 12, 17, 21, 24, 28, 35, 38, 43, 45, 63, 64, 68, 69,
9.	Space required	These plant requires sufficient space because of boilers & auxiliaries	Require less space	
10.	Maintenance cost	Quite high as skilled operating staff are required	Less	* 28 3 17 → 6, 7, 11, 14, 16, 17, 19, 20, 21, 23, 24, 27, 28, 33, 35, 36, 39, 43, 44, 45, 46, 50, 58, 60, 61, 62, 63, 64, 65, 66, 70, 30
11.	Transmission & Distribution cost	Quite low as these are generally located near load centres	Least as they are generally located at the centre of gravity of the load.	
12.	Standby losses	Minimum as the boiler remains in operation even when the turbine is not working	Less standby losses.	* 28 10 7 - 3, 4, 12, 17, 20, 21, 25, 26, 27, 28, 30, 31, 32, 33, 34, 36, 37, 39, 42, 43, 47, 54, 57, 58, 60, 62, 64, 65, 69, 70.

④ control rods:- In a reactor, nuclear chain reaction has to be initiated, when started from cold and chain reaction is to be maintained at steady value during the chain operation of reactor, also the reactor must be able to shut down automatically under emergency conditions.

chain reaction can be controlled either by removing fuel rods or either by inserting neutron absorbing material, which are known as control rods. The control rods must have very high absorption capacity for neutrons. The commonly used control rods are cadmium, boron or hafnium.

⑤ reflector:- The reflector surrounds the reactor core within the thermal shielding. & it helps to bounce escaping neutrons back into the core.

⑥ coolant:- A coolant transfers heat produced inside the reactor to a heat exchanger ~~from~~ for further utilization in power generation.

⑦ Reactor vessel:- This encloses the reactor core, reflector, and shield. It is a strong walled container which also provides entrance and exit passages for directing the flow of coolant.

* Reactor Control

once nuclear fission process is initiated, the neutrons released during nuclear fission process are not used up in propagating the chain reaction & some of these neutrons are lost to the surrounding.

In order to maintain the chain reaction, it is essential that, the no of neutrons after nuclear fission should be slightly more than the no of neutrons before nuclear fission. The ratio is known as multiplication factor.

The multiplication factor k for any reactor is defined as

$$k = \frac{\text{NO of neutrons produced in one generation}}{\text{NO of neutrons produced in the preceding generation}}$$

value of $k=1$, for a multiplication factor, indicates that the chain reaction will continue at a steady state. $k>1$, indicates that chain reaction will be building up. $k<1$ shows the chain reaction will be dying down.

* disposal of Nuclear waste & effluent

The waste associated with nuclear power are as follows.

- ① solid ^{radioactive} waste arising from filter
- ② pieces of discarded fuel element cans.
- ③ splitters
- ④ control rods
- ⑤ sludge from cooling ponds.
- ⑥ gaseous effluents.

There are many ways for disposal of solid fission products, the products can be stored in Shielded storage vaults, it consists of fixing the solid waste in borosilicate glass & then storage of this glass in leak tight capsules or vaults.

* Sometime a suitable containers are filled with radioactive waste & sunk to the bottom of sea & oceans.

- * However the above method does not completely prevent the radioactivity from leaching into the water.
- * Another way of disposal is the separation and transmission of long-lived isotopes to short-lived or stable products following neutron absorption in a breeder or fusion reactor.
- * The sludge from the cooling ponds called as radioactive liquid effluent are first diluted enormously before discharging to sea.
- * These radioactive effluents arise from laundry, personal decontamination etc, together with the activity accumulating from the corrosion of the irradiated fuel elements in the storage ponds.
- * Before discharging to sea emergency dilution takes place & final level of any particular isotope in contained effluent is disposed well below the maximum level of drinking water.
- * Sometime the liquid radioactive waste is converted into cankey of small volume & sealed in metal container & these containers are stored in deep salt mine.
- * However it is safe to store radioactive waste underground in the liquid form in a suitable tanks or the cin technology enables 1000 litres of highly radioactive liquid waste into less than 0.01 m³ of the solid waste.
- * Gaseous effluents are filtered & discharged into atmosphere, the filtered gas is discharged at higher level so that it is dispersed properly. The filtering & discharging areas are kept clean from fire material.

* It is essential to monitor the loss of CO_2 from the reactor to ensure that the loss does not exceed about 1 tone/day. Proper precautions against toxic & radiological hazards are necessary.

* Classification of Reactors.

Nuclear reactors can be classified on the following basis

a) on the basis of Neutron energy. the reactors are classified as - 1) Thermal reactors
2) Fast reactors.

b) on the basis of fuel used

- 1) Natural uranium
- 2) Enriched uranium

c) on the basis of Moderator used

- 1) Graphite reactors
- 2) Beryllium reactors
- 3) water reactors.

d) on the basis of coolant used.

- 1) water cooled reactors
- 2) Gas cooled reactors
- 3) Liquid metal cooled reactors
- 4) organic liquid cooled reactors

e) on the basis of type of core used.

- 1) Homogenous reactors
- 2) Heterogenous reactors.

* Boiling water reactor (BWR) :-

The below fig shows boiling water reactor
in this reactor enriched uranium is used as fuel
water is used as both coolant and moderator.

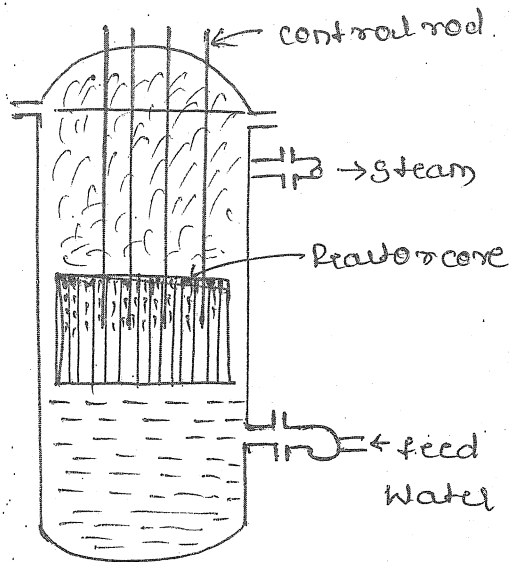

fig - A boiling water reactor.

& steam is generated in the reactor itself.

* Initially the feed water enters into the reactor tank at the bottom & takes up the heat generated due to fission process and gets converted into the steam.

* Steam leaves at the top of reactor and flows into the turbine. uranium fuel elements are arranged in a particular lattice form inside the pressure vessel containing water.

* A BWR have 90-100 fuel rods & these are up to 750 assemblies in core holding up to 140 tonnes of uranium.

* advantages of BWR.

- 1) Heat exchanger circuit is eliminated, which leads to the reduction in cost & increase in thermal efficiency.
- 2) As water is allowed to boil inside the reactor the pressure inside the reactor vessel is considerably lower than in case of pressurized water reactor (PWR)
- 3) The BWR cycle is more efficient than PWR cycle
- 4) A BWR is more stable than the PWR.

5) The metal surface temperature is lower than the PWR cycle since the boiling of water inside the reactor is performed.

* disadvantages of BWR

- ① In view of direct cycle there is a danger of radioactive contamination of steam, which leads to the failure of turbine elements, & it requires more number of safety measures therefore increase in cost.
- ② there is wastage of steam resulting in reduction in thermal efficiency on part load operation.
- ③ power density of BWR is nearly half that of the PWR, & the size of vessel will be considerably large in comparison to that of the PWR.
- ④ A BWR can't meet sudden increase in load.

* pressurized water reactor (PWR)

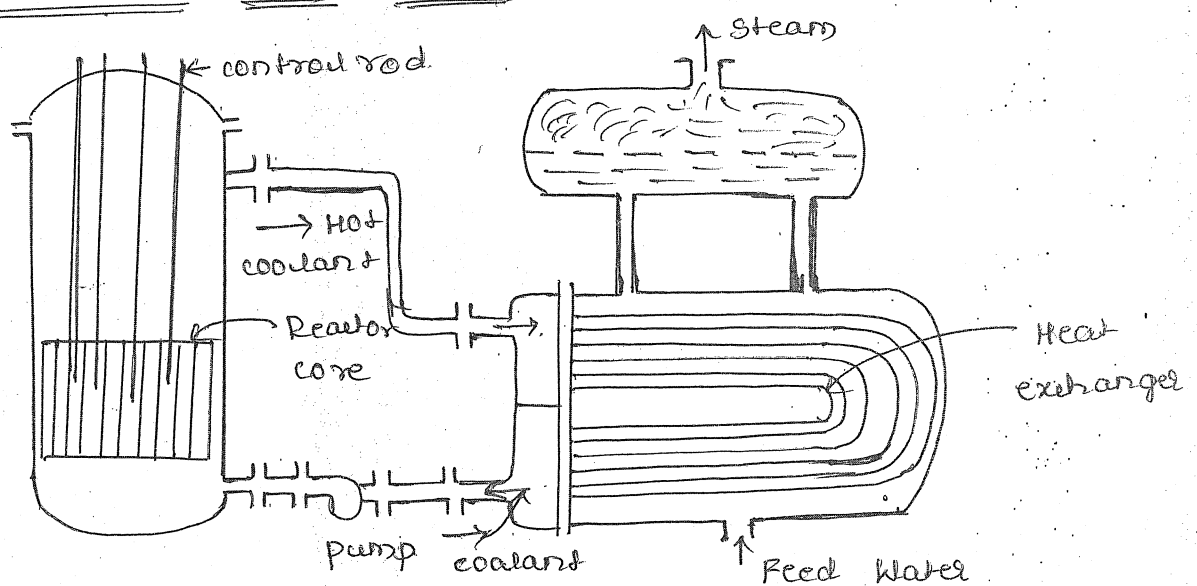

fig-a) A pressurized water reactor.

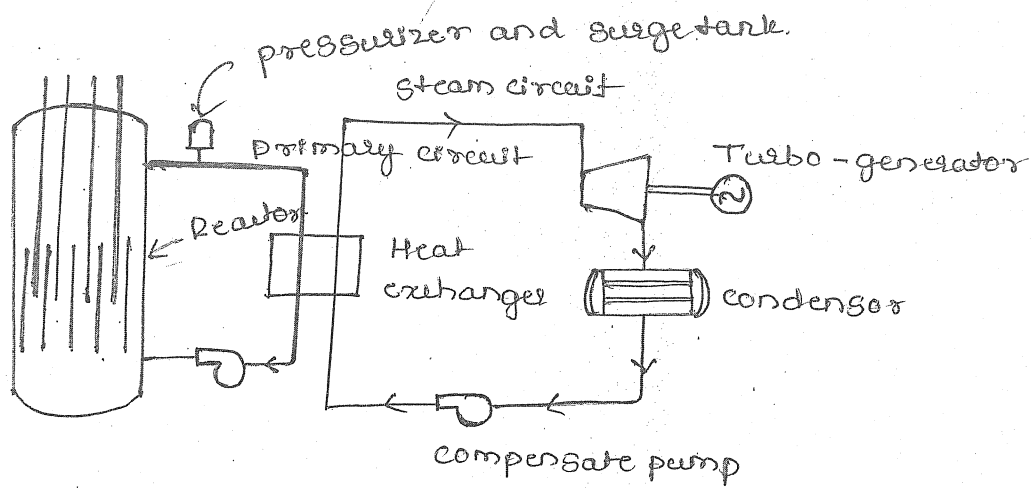

fig-b, Line arrangement of a PWR with heat exchanger and

A pressurized water reactor is as shown in fig a & Line arrangement is as shown in fig b.

- * The fuel used is enriched uranium clad with stain-less steel or zirconium alloy, and water under pressure is used as both moderator and coolant.
 - * However this type of reactor is designed to prevent the boiling of water coolant in the uranium core.
 - * A pump circulates water at high pressure round the core so that the water in liquid form absorbs the heat from the uranium and transfers it into the secondary loop.
 - * The boiler consists of heat exchanger and a steam drum, as shown above a pressurizer and surge tank is tapped into the pipe loop to maintain constant pressure in the water loop throughout the load range.
 - * An electric heating coil in the pressurizer boils the water to form steam & it is collected at the dome water spray is used to condense the steam when pressure is desired to be reduced.
- Since the water passing through the reactor being radio-active & entire primary circuit including heat exchanger has to be shielded.

* Advantage

- 1) A PWR is relatively compact in size compared with other types.
- 2) There is a possibility of breeding plutonium by providing a blanket of D-238.
- 3) The reactor has high power density.
- 4) It is cheap because the ordinary water is used as both moderator & coolant.
- 5) Reactor takes care of load variation by using pressurizer & surge tank.

* disadvantage

- 1) Low thermal efficiency.
- 2) more heat loss due to the use of heat exchanger.
- 3) due to high pressure, a strong pressure vessel is required.
- 4) Lack of flexibility in recharging.
- 5) more safety device is required.
- 6) expensive cladding material is required to avoid corrosion.

* Heavy water cooled & Moderated (CANDU) type reactor

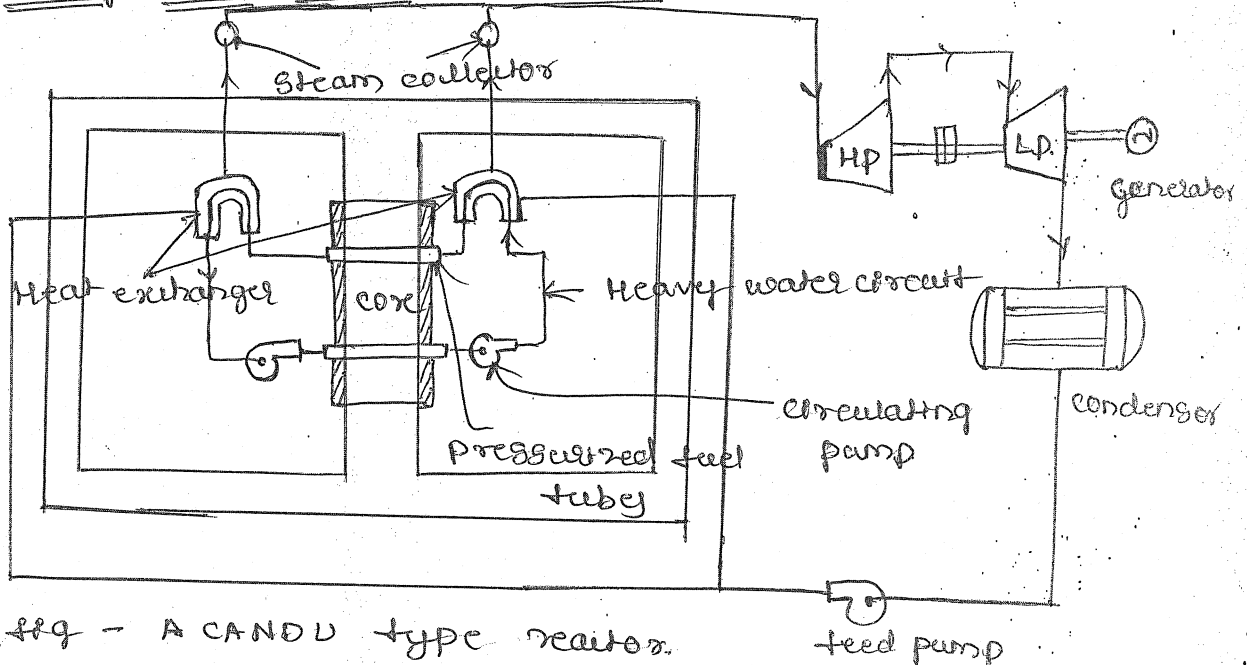

fig - A CANDU type reactor.

The word CANDU - stands for Canadian Deuterium Uranium. These type of reactors are used in those countries which do not produce enriched uranium.

- * Enrichment of uranium is costly & this reactor will make use of natural uranium as fuel & heavy water as moderator.
- * The above fig shows arrangement of CANDU type reactor, initially heavy water is passed through the pressurized fuel tubes & heat exchanger.
- * Heavy water is circulated in the primary circuit in the same way as in PWR & steam is raised in the secondary circuit transferring the heat in the heat exchanger.
- * The control rods are not required in this reactor, reactor control can be achieved by varying the moderator level in the reactor.
- * The advantage of the reactor is that the fuel need not be enriched.
- * Other advantages are, as compared to BWR & PWR reactor vessel needs to be built to withstand low pressure.
- * Control rods are not required, therefore the control reactor is much simpler.
- * The reactor has high multiplication factor & low fuel consumption.
- * The disadvantage of the reactor is - high cost of heavy water, problem of leakage & high standard of design.
- * Gas cooled reactor :- Gas cooled reactor uses a gas CO_2 or helium as a coolant instead of water & graphite as a moderator. A heat exchanger is required.

Gas is circulated through the reactor core & heat exchanger by means of a blower or a gas compressor.

- * Even though gas is inferior to water from the point of view point of heat transfer property, but it offers numerous advantages which are not available with H_2O .
- * A large quantity of gas is required for circulation resulting in increased power consumption for auxiliary therefore overall plant efficiency is low.
- * Graphite as moderator is less effective than water. The gas is circulated at a pressure of $14-28 \text{ kg/cm}^2$.

* Advantages of Gas Cooled Reactor

- 1) Less severe corrosion problems
- 2) Possibility of use of natural uranium as fuel.
- 3) Greater safety in comparison with water cooled reactors
- 4) Contamination problems are moderate.
- 5) Low pressure coolant and relatively high reactor temperature

* The Drawbacks of Gas Cooled Reactor

- 1) Relatively large size of reactor because of use of natural fuel and graphite moderator.
- 2) Extremely low power density.
- 3) Low steam pressure & temperature.
- 4) Large energy consumption by gas blowers because of poor heat transfer characteristics of gases.

* Introduction to Substation equipments

A Substation has several equipments:- transformers, circuit breakers, disconnecting switches, tugs, station buses, insulators, reactors, current & potential transformers, grounding SLM, lightning arrestors, gaps, line traps, protective relay, station batteries etc.

* protective relay:- A protective relay is a type of protective device, which gives an alarm signal or to cause prompt removal of any element from service when the element behaves abnormally.

The functions of protective relay are

- ① The removal of component which is behaving abnormally by closing the trip circuit of circuit breaker or to sound an alarm.
- ② In order to disconnect the abnormally operating part to avoid damage or interference effective operation of ~~the~~ rest of the system.
- ③ To prevent the subsequent faults by disconnecting the abnormally operating part.
- ④ relays are helpful to disconnect the faulty part as early as possible to minimize the damage to the faulty part of the SLM itself.
- ⑤ to improve the SLM performance, SLM reliability, SLM stability & service continuity the relays are helpful.

* Circuit Breaker:- Circuit Breaker normally gets the signal from protective relays to operate, is an automatic switch which can interrupt the fault current. circuit breaker consists of two contacts one is fixed contact & other is moving contact. under normal operating condition both the contacts of CB are fixed, during abnormal running condition the arc is gets introduced b/w the contacts of CB & it trip to separate faulty & unhealthy part of power system.

The circuit breakers are classified on the basis of rated voltage such as low-voltage CB & high voltage CB. Based on the medium of arc extinction, the circuit breakers are also classified as follows.

- a) Air break circuit Breaker (used upto 12kV) & miniature circuit breaker (up to 600V), & air is considered at the atmospheric pressure.
- b) oil circuit Breaker
- c) Minimum oil circuit Breaker (for 3.6 - 245kV)
- d) Air blast circuit breaker (for 245 - 1100kV) where compressed air is used.
- e) SF₆ circuit breaker (for 36 - 420kV) where SF₆ gas is used.
- f) vacuum circuit breaker (up to 36kV) where vacuum is used as arc quenching medium.

⇒ Based on the mode of arc extinction, circuit breakers can be classified as high-resistance interruption circuit breaker & low resistance (zero point interruption) CB.

The circuit breakers are decided based on voltage & fault current of the place where it is to installed.

The voltage rating of circuit Breaker is normally from 1.05 to 1.10 times more than the normal operating voltage. For example if the rating of CB is 400 kV would be 420 kV.

Most of the EHV circuit breakers are provided with auto reclosure.

* Reactors and capacitors:-

To limit the line charging c/n, long distance EHV lines are connected with line reactors at both the ends. These reactors are permanently connected to the line.

* Beside these, there are bay reactors & tertiary reactors which are connected with switches. These are used during light-loading conditions and at the line charging.

* Bay reactors are connected at the substation bay, where a tertiary reactors are connected in the tertiary winding of the transformer.

By using these reactors Ferranti effect is reduced.

* Capacitors are normally connected in low-voltage systems during peak-load conditions, the system voltage falls & therefore capacitive reactive power is required.

* In EHV system, it is preferred to use static VAR system because it takes care of reactive power which can supply both leading and lagging reactive power.

* In distribution system or in sub-transmission system, capacitors are connected to improve the power factor of the system.

* Lightning arrester:- It is also known as surge arrester normally connected b/n the phase and ground at

at the substation, lightning arrester is used to protect the substation equipments due to lightning and switching surges.

* Surge arrestors offer low resistance to the high voltage surge for diverting to the ground.

* after discharging the surge energy to ground, it blocks the normal current flowing to ground by providing high resistance path.

Power Generation and Economics (15EE361) (PGE)

Module-3

Nuclear Power Plants

* Introduction :

- A generating station in which nuclear energy is converted into electrical energy is known as a nuclear power station.
- In nuclear power station, heavy elements such as Uranium (U^{235}) or Thorium (Th^{232}) are subjected to nuclear fission in a special apparatus known as reactor. The heat energy thus released is utilised in raising steam at high temperature & pressure. The steam runs the steam turbine which converts steam energy into mechanical energy. The turbine drives the alternator which converts mechanical energy into electrical energy.
- The most important feature of a nuclear power station is that huge amount of electrical energy can be produced from relatively small amount of nuclear fuel as compared to other conventional types of power plants. It has been found that complete fission of 1kg of Uranium (U^{235}) can produce as much energy as can be produced by burning of 4500 tonnes of high grade coal. Although the recovery of principal nuclear fuels (i.e. Uranium & Thorium) is difficult & expensive, yet the total energy content of the of the estimated world reserves of these fuels are considerably higher than those of conventional fuels, viz, coal, oil & gas. At present energy crisis is gripping up and, therefore, nuclear energy can be successfully employed for producing low cost ~~and~~ electrical energy on a large scale to meet growing commercial & industrial demands.

* Economics of Nuclear power plants :

- Nuclear power is cost competitive with other forms of electricity generation, except in regions where there is direct access to low-cost fossil fuels.
- The decreasing cost of fossil fuels in the past decade has eroded nuclear power's previous cost advantage in many countries.
- Fuel costs for nuclear plants are a minor proportion of total generating costs & often about one-third those for coal-fired plants.
- In assessing the cost competitiveness of nuclear energy, decommissioning & waste disposal costs are taken into account.

The relative costs of generating electricity from coal, gas & nuclear plants are vary considerably depending on location. Coal is, and will probably remain, economically attractive in countries such as India, USA and Australia with abundant and accessible domestic coal resources. Gas is also competitive for base-load plants power in many places, particularly with combine cycle plants. Nuclear energy is, in many places, competitive with fossil fuel for electricity generation, despite relatively high capital costs and the need to internalize all waste disposal & decommissioning costs. If the social, health & environmental costs of fossil fuels are also taken into account, nuclear is outstanding. Nuclear energy averages 0.4 euro - cents/kwh, much the same as hydro, coal is over 4.0 cents (4.1-7.3), gas ranges 1.3-2.3 cents and only wind shows up better than nuclear, at 0.1-0.2 cents/kwh average.

* Merits and Demerits of Nuclear power station

Merits

- (i) The amount of fuel required is quite small. Therefore, there is a considerable saving in the cost of fuel consumption transportation.
- (ii) A nuclear power plant requires less space as compared to any other type of the same size.
- (iii) It has low running charges as a small amount of fuel is used for producing bulk electrical energy.
- (iv) This type of plant is very economical for producing bulk electric power.
- (v) It can be located near the load centres because it does not require large quantities of water (need not be near coal mines). Therefore cost of primary distribution is reduced.
- (vi) There are large deposits of nuclear fuels available all over the world. Therefore such plants can ensure continued supply of electrical energy for thousands of years.
- (vii) It ensures reliability of operation.
- (viii) Very well suited for large power demands.
- (ix) No atmospheric pollution as there is no combustible products.
- (x) Generation of power is not affected by weather conditions.
- (xi) These plants are neat & clean than other plants.

* Demerits of Nuclear power station :

- (i) The fuel used is expensive and is difficult to recover.
- (ii) The capital cost of nuclear plant is very high as compared to other type of plants.
- (iii) The erection & commissioning of the plant requires greater technical know-how.
- (iv) The fission-by products are generally radioactive and may cause dangerous amount of radioactive pollution.
- (v) Maintenance charges are high due to lack of standardisation, moreover high salaries of specially trained personnel employed to handle the plant further raise the cost.
- (vi) Nuclear power plants are not well suited for varying loads as the reactor does not respond to load fluctuations efficiently.
- (vii) The disposal of the by-products, which are radioactive, is a big problem. They have either to be disposed off in a deep trench or in a deep sea away from sea-shore.
- (viii) Failure of controls may lead to nuclear explosion.

* Selection of site for Nuclear power plant :

There are several factors, which are considered in selecting the site for nuclear power station. The selection of site is similar to the thermal power station as water is used as working fluid i.e. steam.

- (1) Availability of water : As in the case of steam power stations, nuclear power stations also requires ample amount of water for cooling & steam generation.
- (2) Disposal of waste : It is one of the very important considerations in the nuclear power station due to dangerous waste/residue of the nuclear substances. Hence an extra care is needed in this respect. The storage of waste, which is to be disposed deep under the ground in sea so that radioactive effect is eliminated.
- (3) Away from populated area : Although there is always tight safety but still there are chances of radioactive radiation, which affects the health of people. Therefore it must be away from the populated areas.
- (4) Nearest to the load centres : Since the transportation & storage requirements are less compared to the coal fired plants. It is preferred to construct the nuclear power plant near the load centres so that transportation of energy at minimum cost can be achieved.

Accessibility by rail and road : Accessibility to the road and rail are the general consideration of almost all the power plants as heavy equipments are to be transported to the sites during the construction. The fuels are also required to transport from the mines during the operation.

* Nuclear Reaction : Nuclear fission Process, Nuclear chain Reaction :

- Types : There are four types of nuclear reactions taking place in nature. These are ① Inelastic scattering ② Elastic scattering ③ Neutron capture ④ fission.

- The last reaction (fission) is the most important from nuclear power engineering. This type of reaction possible only with heavy nuclei such as ${}_{92}^{235}\text{U}$, ${}_{92}^{238}\text{U}$ and ${}_{94}^{239}\text{Pu}$. The nuclei produced after reaction are lighter than original nuclei & since they are now having more binding energies per nucleon they release the energy. This release of energy is due to the increase of mass defect of the lighter nuclei.

- We may say that as a result of fission the target nucleus absorbs thermalised (slow neutron) and becomes highly excited. Therefore it splits into two different masses. The product masses will also be in excited state and they will try to become stable by emitting neutrons.

Methods of producing nuclear reaction : There are a number of methods of starting a nuclear reaction. In one method neutrons are used as bombarding particles. The main advantage of neutrons is that they are neutral (having no charge) and therefore they can make their own way through the shells of electrons & then through the nucleus even at low energy. This is the practical method used in almost all modern fission reactors. Neutrons can be produced in a number of ways.

Chain Reaction : Natural Uranium occurs in three isotopes, U-238 (99.3%), U-235 (0.7%) and U-234 (minute traces). Of these isotopes U-235 is very easily and readily fissionable. If a neutron enters a U-235 atom there is a probability that the nucleus will split and release the enormous amount of energy that binds the nucleus together. This will generate heat in the mass of the Uranium. Each fissioned nucleus ejects two or three neutrons which can again hit Uranium nuclei & accelerate the splitting process even if some of the neutrons are not fully absorbed. This reaction is known as Chain reaction.

Materials fissionable by thermal or low-speed neutrons are U-233, U-235, Pu-239 (plutonium).

Fertile Materials : There are some materials which are not fertile but can be converted to fissile materials. These are known as fertile materials. Pu-239 & U-233 are not found in nature but U-238 & Th-232 can provide produce them by nuclear reactions. When U-238 is bombarded with slow neutrons it produces ${}_{92}^{239}\text{U}$ (with half life of 23.5 minutes) which is unstable & undergoes two beta disintegrations. The resultant ${}_{92}^{239}\text{Pu}$ has half life of 2.44×10^4 years & is a good alpha emitter. Thus

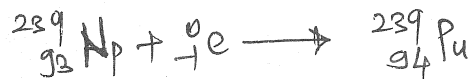
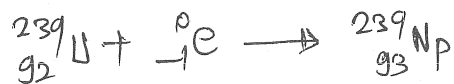

During conversion the above noted reactions will take place. The other isotopes of neptunium such as 2.1 day Np-238 and plutonium can also be produced by the bombardment of heavy particles accelerated by the cyclotron.

The nuclear transformations to convert ${}_{90}^{232}\text{Th}$ to U-233 are expressed as under

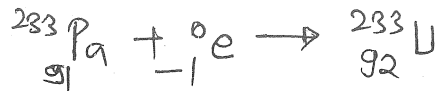
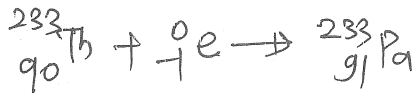
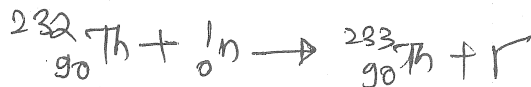

U-235 isotope of uranium is the source of neutrons required to derive Pu-239 and U-233 and U-238 & Th-232 respectively.

This process of conversion is performed in the breeder reactors.

* Nuclear Energy :

In nuclear physics the energy is expressed in mega electron volt (MeV) & mass is in atomic mass unit (amu). One electron volt is the energy gained by an electron passing through the potential difference of one voltage. Since the charge of electron is 1.602×10^{-19} C.

$$1\text{eV} = 1.602 \times 10^{-19} \text{ Joule}$$

$$1\text{MeV} = 10^6 \times 1.602 \times 10^{-19} = 1.602 \times 10^{-13} \text{ J}$$

According to Einstein Mass-Energy relation ($E = mc^2$), where m is mass in kg, E is Energy in joules & c is the velocity of light in metre/second, the energy corresponding to 1amu is ($= 1.66 \times 10^{-27}$ kg) will be as follows.

$$1 \text{ amu} = 1.66 \times 10^{-27} \times (3 \times 10^8)^2 = 1.494 \times 10^{-10} \text{ J}$$

$$1 \text{ amu} = \frac{1.494 \times 10^{-10}}{1.602 \times 10^{-13}} \text{ MeV} = 931 \text{ MeV}$$

The sum of masses of the protons and neutrons exceeds the mass of the atomic nucleus. This difference in mass is called as mass defect. The energy associated with the mass defect is known as the binding energy of the nucleus, which is a direct measure of nuclear stability. The energy can be released in two ways:

1. By combining the light nucleus and the energy released, known as Fusion.
2. By breaking the heavy nucleus and the energy released, known as Fission.

Fission is most widely used in nuclear power stations. The materials fissionable by thermal or low speed neutrons are ${}_{92}^{233}\text{U}$, ${}_{92}^{235}\text{U}$ & ${}_{94}^{239}\text{Pu}$

* Nuclear Fuels :

The energy fuels mainly used are natural Uranium (0.7% U-235), Enriched Uranium, Plutonium (Secondary fuel) and U-233 (Secondary fuel available from breeder reactor), Natural uranium is the parent material.

- In order to use a naturally occurring uranium as fuel, it must go through the purification process.

* The materials U-235, U-233 and Pu-239 are called fissionable materials. The fissionable nuclear fuel occurring in nature is uranium, of which 99.3% is ${}_{92}^{238}\text{U}$ and 0.7% is ${}_{92}^{235}\text{U}$ and ${}_{92}^{238}\text{U}$ is only a trace amount, out of these isotopes only ${}_{92}^{235}\text{U}$

could fission in a chain reaction.

* Fissionable material ${}_{94}^{239}\text{Pu}$ and ${}_{92}^{233}\text{U}$ are formed in the nuclear reactors during fission process from ${}_{92}^{238}\text{U}$ and ${}_{90}^{232}\text{Th}$ respectively due to absorption of neutrons

14, 43, 45, 61, 64, without fission.

The process is given as below.

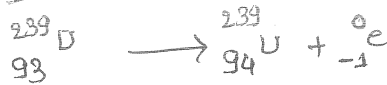
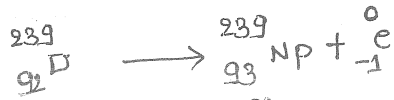
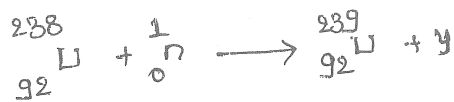

The above process is called conversion. Absorption of a neutron by U-238 produces U-239, which is unstable with life period of 23 minutes, and decays into neptunium with emission of an electron.

${}_{93}^{239}\text{Np}$ which has half life period of 2.3 days & transformed into Pu-239 which is long life fissionable isotope of plutonium.

Fissionable U-233 is produced in the following way

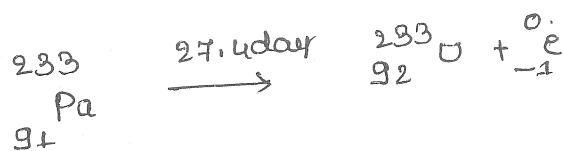
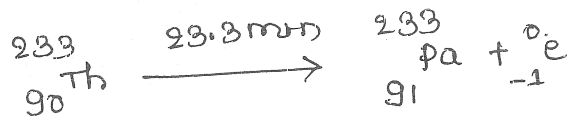
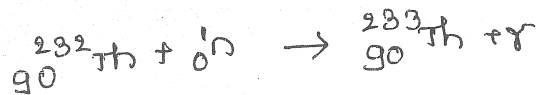

process is known as breeding.

* Nuclear power plant layout

The concept of Nuclear power generator is much more similar to that of the conventional steam power generator. The difference lies in the steam power plant, coal or oil burning furnace is replaced by the nuclear reactor and heat exchanger in nuclear power plant.

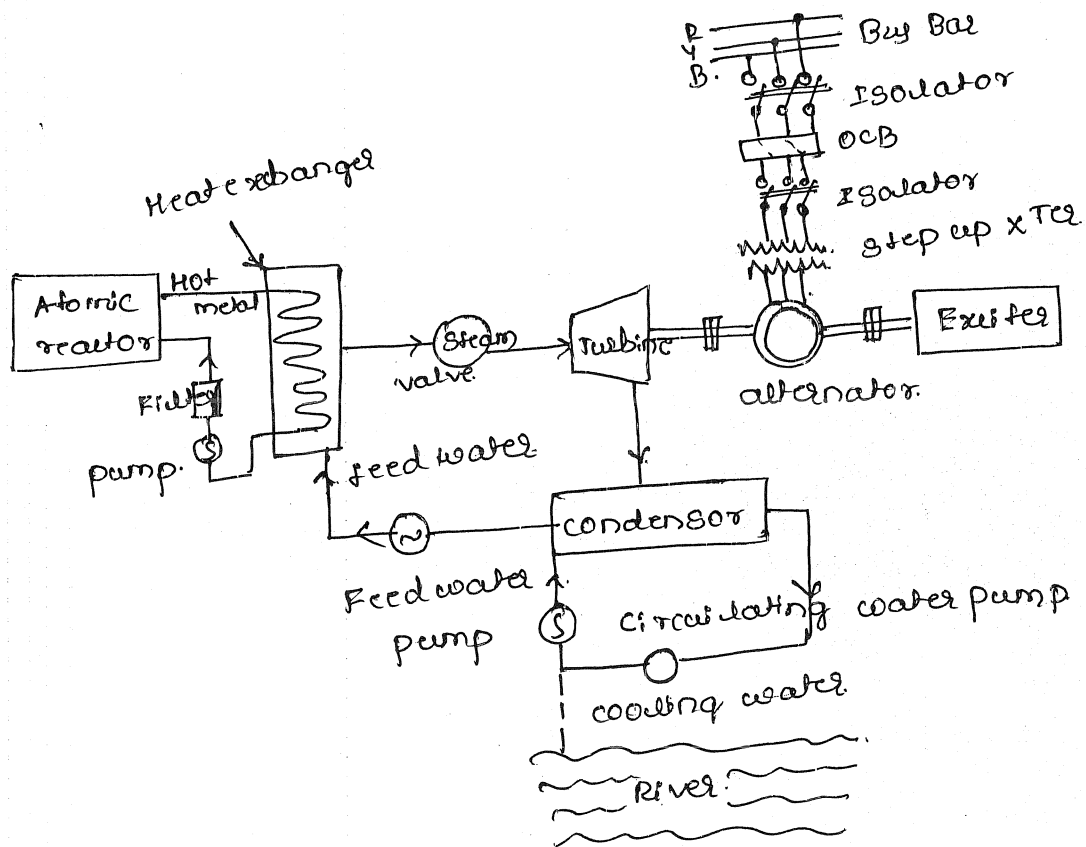

Fig - Schematic arrangement of Nuclear power plant.

The Schematic arrangement of Nuclear power plant is as shown in the above fig. A nuclear power plant consists of Nuclear reactor, Heat exchanger, Steam turbine, alternator, condenser, water pumps etc.

- * The large amount of heat energy is produced in breaking of atoms of uranium or other similar metals of large atomic weight into metals of lower atomic weight by fission process in a atomic reactor.
- * Now the generated heat energy is extracted by pumping fluid or molten metal like liquid sodium or gas through the pipe.
- * The Hot metal or gas is then allowed to exchange its heat with the help of Heat exchanger as shown

above. In heat exchanger the gas is heated or Steam is generated which is used to drive gas or Steam turbine coupled to the alternator, thereby generating electrical energy.

* While deciding the layout of nuclear power plant, care must be taken that, the operation of plant must be safe, operating convenience & capital economy.

* Nuclear reactor & its control:

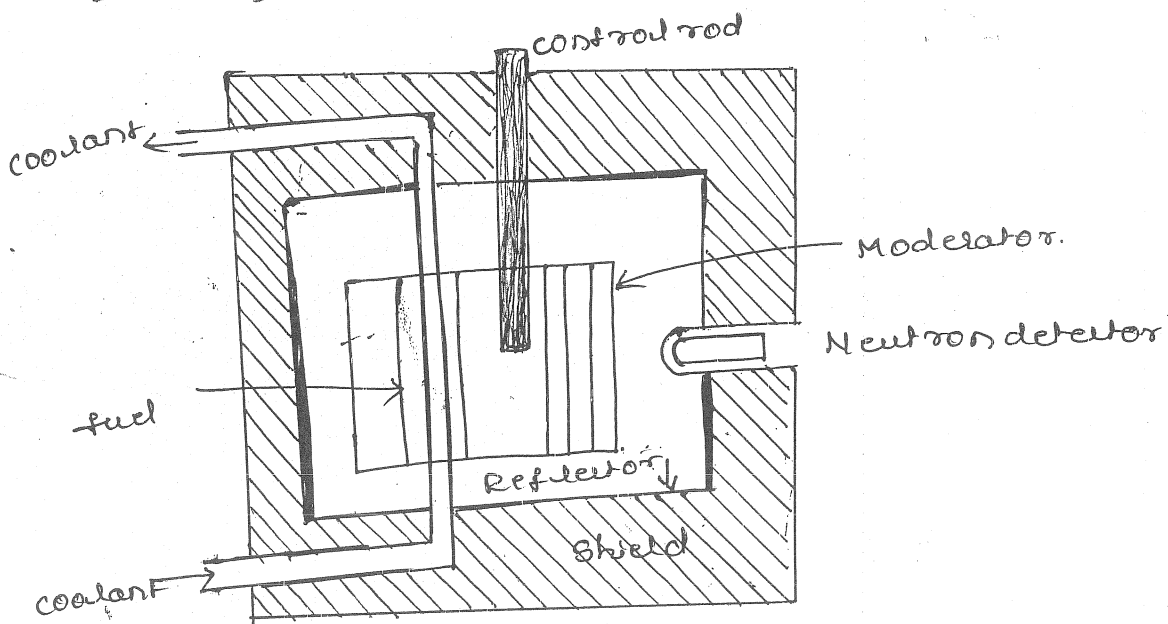

fig a. Basic components of a Nuclear reactor.

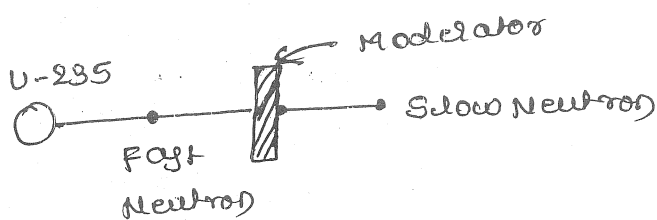

fig-b) Moderator slows down a Fast neutron.

Nuclear reactor is a part of Nuclear power plant where fuel is subjected to nuclear fission process and energy is released.

* The main function of reactor is to control the emission and absorption of neutrons.

Nuclear reactor is consisting of →

- ① Fuel rods
- ② Reactor core
- ③ moderator
- ④ Shielding
- ⑤ control rods
- ⑥ Reflector
- ⑦ coolant
- ⑧ Reactor vessel.

* Fuel rod :- A fuel rod is a tube, filled with pellets of uranium, normally used fuel in a reactor are ${}_{92}^{235}\text{U}$, ${}_{92}^{235}\text{Pu}$, ${}_{92}^{233}\text{U}$, among three ${}_{92}^{235}\text{U}$ is naturally available upto 0.7% in the uranium ore.

* Reactor core :- It contains a number of fuel rods which are made up of fissile material. They may be diluted with non-fissionable material for better control of the reaction or to reduce the damage from fission product poison.

It is desirable to use reactor core as cubical or cylindrical in shape rather than spherical.

* moderator :- The purpose of moderator is to moderate or to reduce the neutron speed to a value that increases the probability of fission occurring. The Graphite, heavy water or beryllium can be used as moderator with natural uranium. However the ordinary water is used as moderator with enriched uranium.

* Shielding :- Its purpose is to provide the protection from the α and β particle radiations, and γ -rays as well as neutrons which are produced due to the nuclear fission process. & it helps to prevent the reactor wall from getting heated.

④ control rod:- In a reactor, nuclear chain reaction has to be initiated, when started from cold and chain reaction is to be maintained at steady value during the chain operation of reactor, also the reactor must be able to shut down automatically under emergency conditions.

chain reaction can be controlled either by removing fuel rod or either by inserting neutron absorbing material, which are known as control rod. The control rod must have very high absorption capacity for neutrons. The commonly used control rod are cadmium, boron or hafnium.

⑤ reflector:- The reflector surrounds the reactor core within the thermal shielding. & it helps to bounce escaping neutrons back into the core.

⑥ coolant:- A coolant transfers heat produced inside the reactor to a heat exchanger ~~from~~ for further utilization in power generation.

⑦ Reactor vessel:- This encloses the reactor core, reflector, and shield. It is a strong walled container which also provides entrance and exit passage for directing the flow of coolant.

* Reactor Control

Module - 4 Substations

Normally large power generating stations are built far away from the load centres, there are a number of transformations and switching stations which are built in b/w generating stations & to the customer, which are known as substations.

A typical substation consisting of transformers, circuit breakers, disconnecting switches, station bays, insulators, reactors, capacitors, CT & PT's, grounding s/m, LA & spark gaps, wave traps, protective relay, station batteries etc.

* Types of Substations

depending on the purpose, the substations may be classified into five categories.

① Generating Substations or Step up Substations:-

In generating substation, the generating voltages are limited and need to be stepped up to transmission voltage therefore large amount of power generation is to be transmitted over long period, in large amount.

Each generating unit is connected to the generating transformer to increase the secondary voltage up to transmission voltage level.

* Grid Substations:- These substations are located in the intermediate points b/w the generating stations & load centres. The main purpose of these substations are to provide connections of low voltage lines, some compensating devices etc.

* Secondary Substations:- Secondary substations are connected with main grid substation with the help of secondary

secondary transmission line. The voltage at these substation is stepped down to the transmission voltage. Some of the large consumers are also connected to these substations.

* distribution substations :- These substation is located where subtransmission voltage is to be stepped down to the supply voltage. These substations feed power to the actual consumers through distributors & service wire.

* Special purpose substations :- These substations are specified for some special applications such as for bulk power transmission & supply of industrial load.

for example → Traction substation & mining substation.

However some special considerations are required in these substations such as load distribution in phases in traction substation & safety precautions in the mining substation.

* depending on physical feature the substations are also classified as follows.

- ① outdoor type
- ② indoor type
- ③ pole mounted
- ④ underground type

* outdoor type :- Normally outdoor substations are used for 33-kV voltage and above for cost and safety reasons. The air clearance required is more.

All the equipments are open in the air & control and monitoring is performed inside the control room.

* Indoor type :- The equipments of this substation are in a room. The operating voltages are normally 400V &

11kV. The substations are usually located in big cities.

* pole mounted or open type :- as the name indicates these substations are mounted on pole, they are very simple and cheap, as there is no building for housing the equipments are required. these substations are having very low capacity 500-kVA transformer.

* underground type :- these substations are used when space is not available. whole substation is made underground. The size of the substation can be high or low depending upon the capacity.

usually the design of substation aims to achieve a high degree of continuity, maximum reliability and flexibility, to meet these objectives with the highest possible economy.

* Location of Substation

Location of distribution substation depends on the several factors such as voltage level, voltage regulation considerations, subtransmission costs, substation costs, & the cost of primary feeders, mains & distribution transformer.

Some non-technical factors such as availability of land, public safety etc. are also important. as far as the industrial and commercial substations are concerned, they are normally located near to or within the premises of the consumer.

* to select ideal location for a distribution substation, following rules are to be considered →

- ① Locate the substation as much as close to the load centre of its service area.
 - ② Locate the substation such that proper voltage regulation can be obtained without taking extensive measures.
 - ③ Select the substation location such that it provides proper access for incoming subtransmission line and outgoing primary feeders and also capable to handle the future expansion.
 - ④ Selected location should be in accordance with the the electricity rule and land use regulation.
 - ⑤ The selected substation should help to minimize the number of customers affected by any service discontinuity.
-

* Bus bar arrangement Schemes.

The choice of bus scheme depends on the relative importance assigned to such items as safety, reliability, voltage level, simplicity of relay, flexibility of operation, cost, maintenance, available ground area, location of connecting lines, provision of expansion.

* Single Bus Scheme

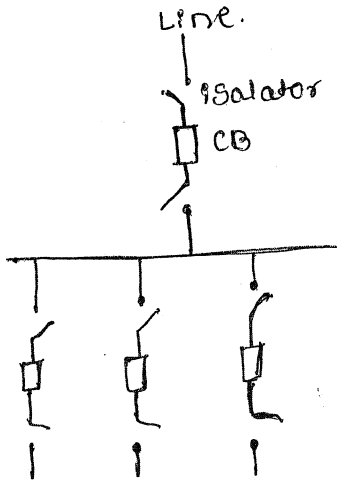

fig - Single bus scheme.

Above fig shows typical

single bus scheme for voltage of 33kV or lower & has a simple design.

* It is used in small outdoor substations with few no of outgoing or incoming feeders and lines.

* The main advantage is its cost is low.

at the same time it has several disadvantages they are as follows. (1) Dependency on a single bus may cause serious outage during the bus failure.

(2) difficulty to do any type of maintenance work.

(3) Bus can't be extended without completely de-energizing the substation.

(4) It can be used only where load can be interrupted.

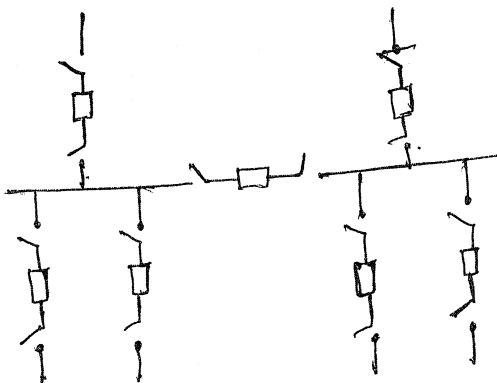
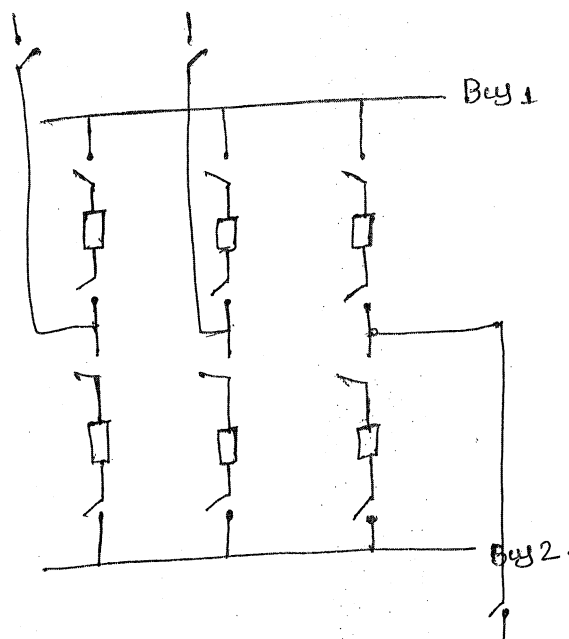

fig b) Single bus scheme with bus sectionalizer.

As shown in the above fig, In single-bus bar scheme with sectionalizer, in which bus bar is normally divided into two sections, with the help of breaker & isolator.

* The incoming & outgoing circuits are evenly distributed each section will act as a separate bus bar.

* double bus with double breaker



Such type of schemes are much more useful in most of the purpose. addition of load as well continuity supply increases the cost. The main advantages are:-

- a) Each circuit has two dedicated breakers.
- b) Any breaker can be taken out for maintenance.
- c) It is more reliable than single bus scheme.
- d) It is much more flexible.

* double bus with single breaker

As shown below this scheme uses two main buses & connected with two disconnecting switches → a bus tie-CB or bus coupler is used as it enables

a load change over from one bus to other.

the advantages are

- ① It permits some flexibility with two operating buses
- ② either bus 1 or bus 2 can be isolated for maintenance
- ③ circuit can be transferred by the use of the breaker & isolator.

*disadvantages are

- a) an extra breaker is required
- b) four isolators are required per circuit.
- c) Bus tie-breaker fault takes entire substation out of service.
- d) It will not permit maintenance without stopping supply

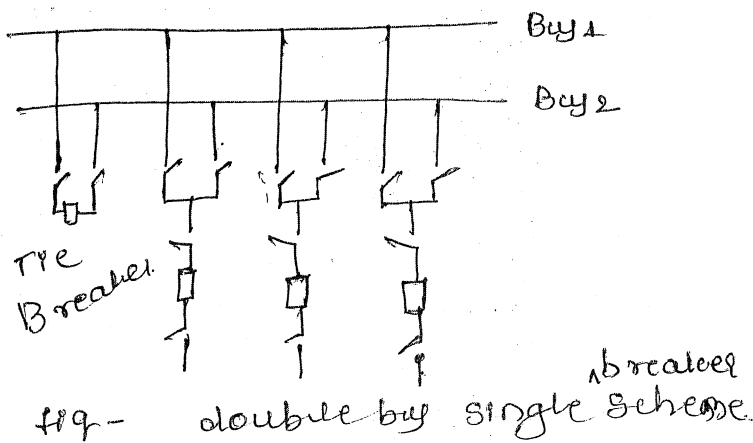

* Main & transfer Bus.

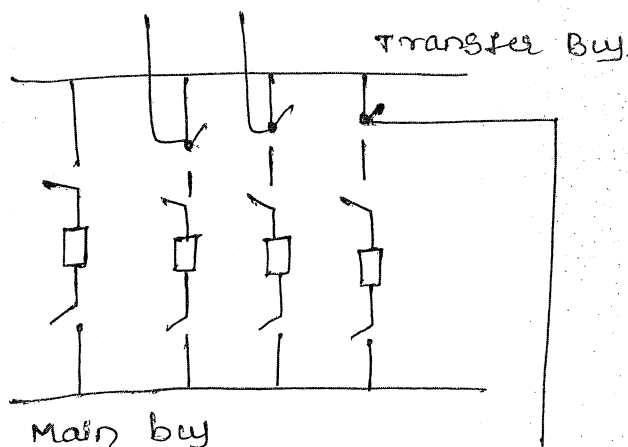

fig - Main bus & transfer Bus.

The above fig shows main & transfer bus, which is more commonly used in distribution substation.

In this scheme several circuit breakers are saved, however one extra breaker is provided to tie the main and transfer bus.

* the main advantage of this scheme is its initial cost is low, & ultimate cost is also low.

* any breaker can be taken out of service for maintenance and potential device may be used on the main bus for relaying.

* The main drawback of the STM is - Switching is some what complicated when maintaining a breaker, failure of bus, or any of CB results in complete shut down of entire substation. & it may addition of circuit breakers.

* Ring Bus

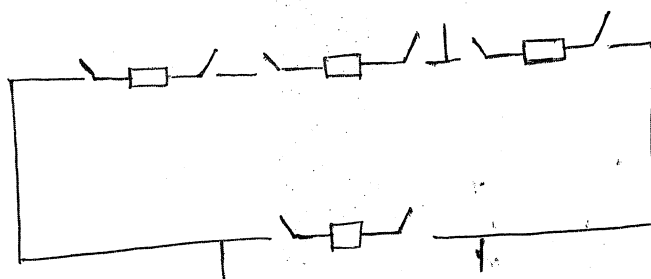

fig - Ring bus or mesh scheme

* disadvantage

- ① Automatic reclosing & protective relaying circuitry is complex
- ② during fault clearance ring is divided into two sections.

The scheme is also known as mesh scheme, it requires

- only one CB per circuit. The advantages of the scheme are →
- ① low initial cost
 - ② flexible operation for breaker maintenance
 - ③ any breaker can be taken out for maintenance purpose without interrupting load.
 - ④ it does not use main bus
 - ⑤ each circuit is fed by two breakers
 - ⑥ all switching is done through breaker.

* Breaker and a Half with two main Buses

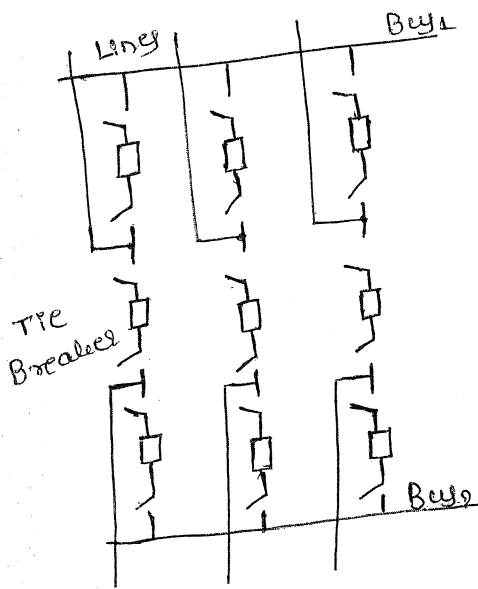

fig - Breaker & a half scheme

It is an improvement double-bus, double-breaker scheme to save the cost of breakers. As shown above three breakers are used in serving b/n the main buses.

* Under normal operating condition all the breakers are closed & the main buses are energized.

* To trip a circuit, two associated CBs must be opened. The disadvantage of the scheme is complicated protection.

* Advantages

- ① Most flexible operation.
- ② High reliability
- ③ All switching is done with breakers
- ④ either main bus can be taken out of service with supply interruption.
- ⑤ Bus failure does not remove any feeder circuit from service.
- ⑥ Simple operation & no disconnect switching required for normal operation.

* Double bus-bar with Bypass Isolators

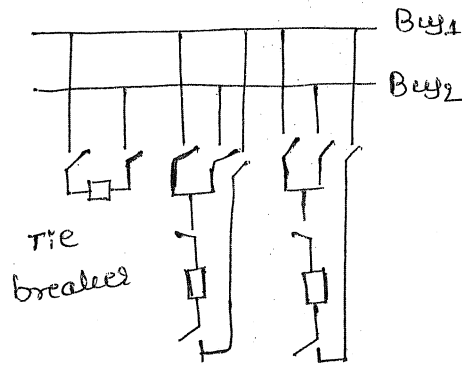

fig - double bus with bypass isolator.

This is a scheme similar to main & transfer bus out of both bus any bus can act as main bus & other bus will act as transfer bus.

* The main advantage of the scheme is any breaker can be taken out of service without interrupting the supply of any feeder. The scheme is very simple & economical.

* Grounding :- A proper grounding is must required for safe and reliable operation of the substation.

* all power systems will operate with grounded neutral.

* The neutral earthing is one of the most important feature in substation design.

* due to defective electrical apparatus & some other reasons, electricity causes electric shock hazards for human being and animals. \therefore it is a common practice to connect electric supply line to ground at suitable points.

* Grounding is a measure taken to increase the reliability of supply service, as it provides stability of voltage conditions, prevents excessive voltage peaks during the disturbance.

* Resistance Grounding.

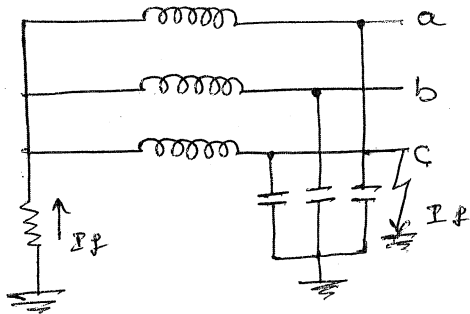

Fig - Resistance grounding.

For the voltage level b/w 3.3kV & 22kV, the ground c/n is not large to use reactance grounding.

* The ground fault c/n, for solid grounding become very high. ~~high~~ ∴ the neutral point is connected with resistance which is known as resistance grounding.

* To limit the fault c/n high resistance is used which save the power loss & improves the stability of the s/m during the fault.

* For the ckt below 3.3kV, there is no need of external resistance because the earth fault c/n can be limited due to inherent ground resistance i.e. 1.5ohm.

* In resistance grounding s/m, the power loss during the line to ground fault is the main consideration.

* Normally resistor value is given by $R = \frac{V_{LL}}{\sqrt{3}I_f}$.

* interconnection of substations.

Where I is the full load c/n of largest m/c in amperes.

* Peterson gave the formula for resistor

$$R = (2.0 \text{ to } 1.25) \frac{1}{\text{cat}^2 \text{etc.}}$$

Where c_a, c_b, c_c are capacitances of each phase to earth.

* Reactance Grounding.

Between the voltage 3.3 kV and 22 kV, the solid grounding is not used due to excessive fault c/n & \therefore resistance & reactance grounding must be used.

To limit the fault c/n resistance is popular in UK, whereas reactance is popular in Europe.

* The reactance connected b/w neutral & ground provides the lagging c/n which neutralize the capacitive c/n.

* there is no rule for use of either resistance or reactance.

* whenever charging c/n is high, such as for cables, EHV & long capacitors etc the reactance grounding is used. otherwise resistance grounding is preferred.

* The grounding of solid & reactance is decided by following relation for solid grounded s/n $X_0/X_1 \leq 3.0$

91/5/17 * 12, 15, 101, 15
- 3, 5, 6, 17, 24, 30, 33, 35, 44, 45, 51, 52, 64, 69.

10/5/17 - 7, 12, 14, 15, 17, 19, 20, 24, 25, 27, 34, 50, 51, 53, 56, 64, 68,

* Introduction to Substation equipments

A Substation has several equipments:- transformers, circuit breakers, disconnecting switches, fuses, station buses, insulators, reactors, current & potential transformers, grounding slm, lightning arrestors, gaps, line traps, protective relay, station battery etc.

* protective relay:- A protective relay is a type of protective device, which gives an alarm signal or to cause prompt removal of any element from service when the element behaves abnormally.

The functions of protective relay are

① The removal of component which is behaving abnormally by closing the trip circuit of circuit breaker or to sound an alarm.

② In order to disconnect the abnormally operating part to avoid damage or interference effective operation of ~~the~~ rest of the system.

③ To prevent the subsequent faults by disconnecting the abnormally operating part.

④ relays are helpful to disconnect the faulty part as early as possible to minimize the damage to the faulty part of the slm itself.

⑤ to improve the slm performance, slm reliability, slm stability & service continuity the relays are helpful.

* Circuit Breaker:- Circuit Breaker normally gets the signal from protective relays to operate, is an automatic switch which can interrupt the fault current. circuit breaker consists of two contacts one is fixed contact & other is moving contact. under normal operating condition both the contacts of CB are fixed, during abnormal running condition the arc is gets introduced b/w the contacts of CB & it trip to separate faulty & unhealthy part of power system.

The circuit breakers are classified on the basis of rated voltage such as low-voltage CB & high voltage CB. Based on the medium of arc extinction, the circuit breakers are also classified as follows.

- a) Air break circuit breaker (used upto 12kV) & miniature circuit breaker (up to 600V), & air is considered at the atmospheric pressure.
 - b) oil circuit breaker
 - c) Minimum oil circuit breaker (for 3.6-245kV)
 - d) Air blast circuit breaker (for 245-1100kV) where compressed air is used.
 - e) SF₆ circuit breaker (for 36-420kV) where SF₆ gas is used.
 - f) Vacuum circuit breaker (up to 36kV) where vacuum is used as arc quenching medium.
- ⇒ Based on the mode of arc extinction, circuit breakers can be classified as high-resistance interruption circuit breaker & low resistance (zero point interruption) CB.

The circuit breakers are decided based on voltage & fault current of the place where it is to installed.

The voltage rating of circuit Breaker is normally from 1.05 to 1.10 times more than the normal operating voltage. For example if the rating of CB is 400kV would be 420kV.

Most of the EHV circuit breakers are provided with auto reclosure.

* Reactors and capacitors:-

To limit the line charging c/n, long distance EHV lines are connected with line reactors at both the ends, These reactors are permanently connected to the line.

* Beside these, there are bay reactors & tertiary reactors which are connected with switches. These are used during light-loading conditions and at the line charging.

* Bay reactors are connected at the substation bay, where a tertiary reactors are connected in the tertiary winding of the transformer.

By using these reactors Ferranti effect is reduced.

* Capacitors are normally connected in low-voltage systems during peak-load conditions, the system voltage falls & therefore capacitive reactive power is required.

* In EHV system, it is preferred to use static VAR system because it takes care of reactive power which can supply both leading and lagging reactive power.

* In distribution system or in sub-transmission system, capacitors are connected to improve the power factor of the system.

* Lightning arrester:- It is also known as surge arrester normally connected b/n the phase and ground at

at the substation, lightning arrester is used to protect the substation equipments due to lightning and switching surges.

* Surge arrestors offer low resistance to the high voltage surge for diverting to the ground.

* after discharging the surge energy to ground, it blocks the normal current flowing to ground by providing high resistance path.

* Isolators & fuses :- An isolator operates under no-load condition [high voltage disconnect switch] and does not have any cin breaking & making capacity & it is used for disconnecting the CB from live part.

Isolators are used in addition to CBS which can make & break the circuit under normal & short circuit conditions.

* for opening a circuit, the CB is opened 1st & then Isolator is operated.

* In addition to Isolator & circuit breaker, another device known as load break switch combining the function of Isolator and switch.

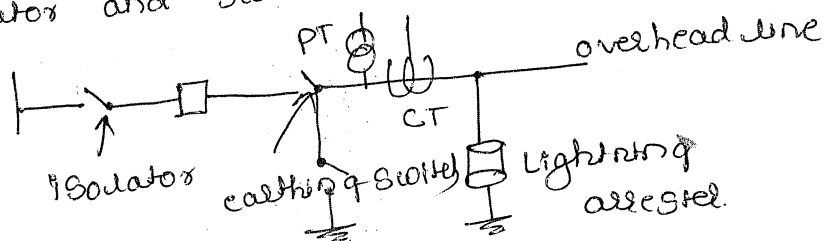

Fig - Isolator position

A fuse is a simple protective device, used for protection of excessive currents due to overload or fault. They are normally used up to 600V installations. HRC fuses are more reliable & give better discrimination & accurate characteristics.

* power transformers :- A power transformer is used in a sub-station to step up or step-down the voltage.

Except at the power station, all the subsequent sub-stations use step-down transformers to gradually reduce the voltage of electric supply and finally deliver it at utilisation voltage. The modern practice is to use 3-phase transformers in substations, even 3 single phase bank of transformers can be used.

* The use of 3-phase transformer permits two advantages

- 1) Only one 3 phase load tap changing mechanism can be used.
- 2) 3-phase transformer installation is much simpler than three single phase transformer.

The transformer specification includes

- | | | |
|------------------|--------------------|---------------------------------|
| 1) kVA rating | 4) Rated frequency | 7) Type of core |
| 2) Rated voltage | 5) connections | 8) type (power or distribution) |
| 3) No of phases | 6) Tapping if any | 9) Ambient Temperature |

* ~~High Voltage~~

* High voltage disconnect switches [isolators & trips] :-

In sub-stations, it is often desired to disconnect a part of the system for general maintenance and repairs. This is accomplished by an isolating switch or isolator.

* An isolator is essentially a knife switch and it is designed to open a circuit under no load. In other words, isolator switches are operated only when the line in which they are connected will not carry current.

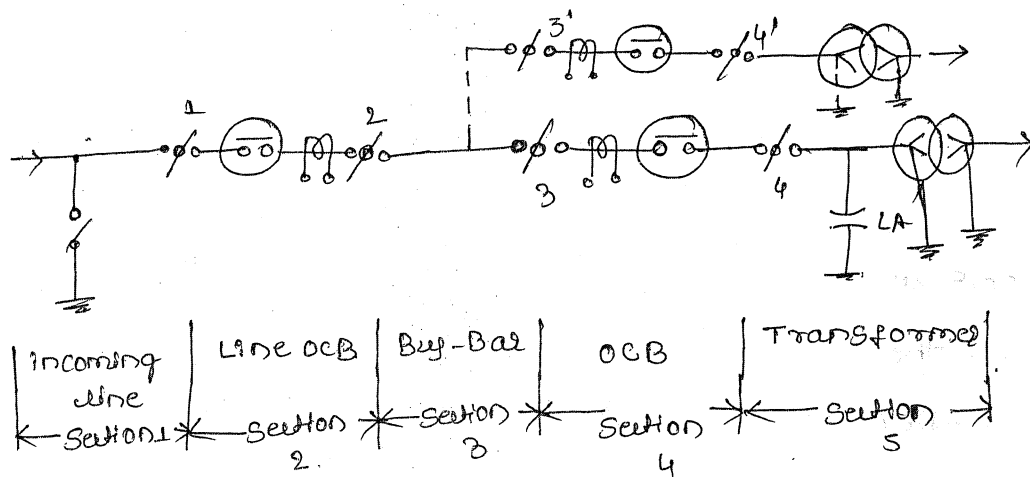

Fig - typical sub-station

- The above fig shows use of isolators in a typical sub-station, The entire substation is divided into 5 sections
- * Each section is disconnected with the help of isolators for repair and maintenance purpose.
 - * for example if section 2 is taken for repair purpose initially, open the o/c B in this section & then open isolators 1 and 2, once section is repaired, close isolators 1 & 2 first & then the o/c B.
 - * High voltage insulators :- The insulators serve for two purposes. They support conductors (or bus bars) and confine the c/s to the conductors.
 - * most commonly used material for insulator is porcelain
 - * There are several types of insulators (pin type, suspension type, post insulator etc).
 - * The use of insulator in sub-station depends upon the service requirement, for example post insulator is used for buy-bar,
 - * A post insulator consists of a porcelain body cast

iron cap and flanged cast iron base. The hole in the cap is threaded so that buy-bay can be directly bolted to the cap.

* Voltage Regulators :- voltage regulators are the devices which are used to supply the regulated voltage to power systems.

Voltage regulator is designed to maintain a constant voltage level automatically. depending upon the design, it may be used to regulate one or more AC or DC voltages. In an electronic power plants, the voltage regulators may be installed at a substation or along distribution lines so that all customers receive steady voltage independent of how much power is drawn from the line.

* Storage Batteries :- In electric power stations and large capacity substations, the operating and automatic control ~~and~~ circuits, the protective relay systems, as well as emergency lightning circuits, are supplied by station batteries.

* The latter constitute independent sources of operative and guarantee operation of the above mentioned circuits irrespective of any fault which has occurred in the station or substation, even in the event of complete disappearance of the ac supply in the installation.

* station batteries are assembled of a certain number of accumulator cells depending on the operating voltage of the respective dc circuits.

Lead-acid batteries are most commonly used in power stations and substations because of their higher cell voltage & low cost.

* Measuring instruments :- Ammeters, voltmeters, watt meters, kWh meters, kVARh meters, power factor meters, reactive volt-ampere meters are installed in substations to control & maintain a watch over the c/m flowing through the circuit and over the power loads.

* power line carrier communication equipment :-

Such equipment is installed in the substations for communication, relaying, telemetering or for supervisory control. The equipment is suitably mounted in a room known as carrier room and connected to the high voltage power circuit.

* Interconnection of power stations.

The connection of several generating stations in parallel is known as interconnected grid system.

The various problems facing the power station engineers are reduced by interconnecting different power stations in parallel.

* even though the interconnection of station includes extra cost, yet considering the benefits, nowadays such aim is gaining more importance.

* Some advantages of interconnected power station are as follows =>

1) Exchange of peak loads :- The peak load of the power station can be exchanged with the help of interconnected SIm.

If the load curve of a power station shows a peak demand which is greater than the rated capacity of the plant, then excess load can be shared by the other stations interconnected with it.

2) use of older plants :- The interconnected power SIm make it possible to use the older plants & less efficient plants to carry peak load for short duration.

3) Ensure economical operation :- interconnected power SIm make the operation of concerned power station quite economical, because the sharing of load among the station is arranged such that, more efficient stations operate continuously throughout the year at a higher load factor & less efficient plants work only for peak load condition.

4) increase diversity factor

5) ~~Reduce~~ reduce plant reserve capacity

6) Increase the reliability of supply.

* ~~Example~~

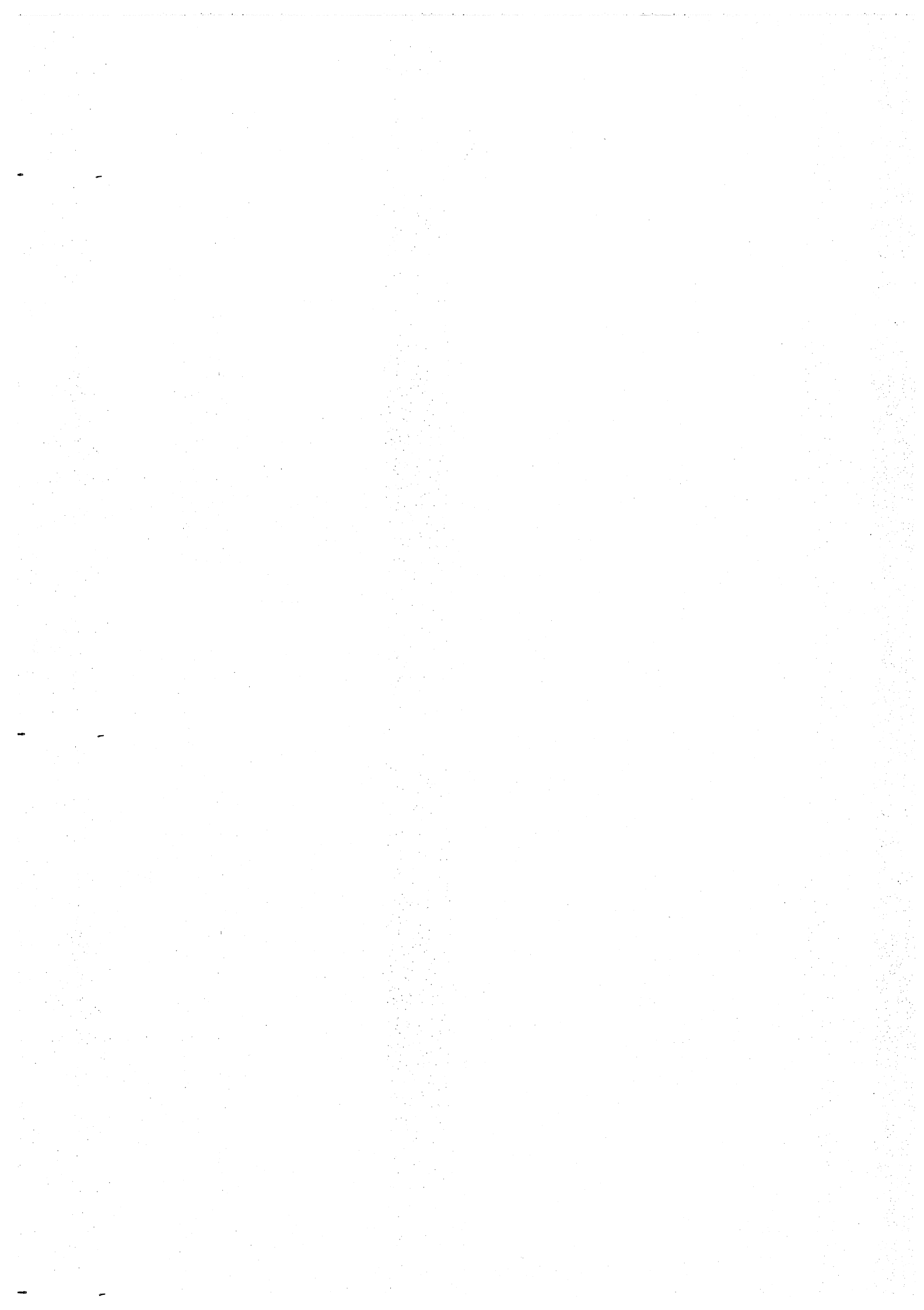

Module -5 - Economics

A power station is required to deliver power to a large number of consumers to meet their requirements.

* However while designing and building a power station, efforts should be made such that the overall economy, per unit cost of production is as low as possible.

* There are several factors which influence the production cost such as cost of land & equipment, depreciation of equipment, interest and capital investment etc.

* Economics of power generation

The art of determining the per unit [ie one kWh] cost of production of electrical energy is known as economics of power generation.

The economics of power generation is considered as most important factor in power plant engineering.

* A consumer will use electric power only if it is supplied at reasonable cost. Therefore power s/m engineer has to select the convenient method to produce electric power as cheap as possible so that consumers are satisfied to use electrical methods.

The following factors are more commonly used in the economics of power generation :-

i) Interest :- The cost of use of money is known as interest. The rate of interest depends upon market position & other factors, usually it varies from 4 to 8% per annum.

ii) Depreciation :- The decrease in the value of the power plant equipment & building due to constant use is known as depreciation.

* Effect of variable load on power system.

The load on a power station varies from time to time due to uncertain demand of the consumers known as variable load on power station.

A power station is designed to meet the load requirements of consumer, a consumer require their small or bulk power ~~require~~ in accordance with the demand of their activity.

* The variable load on a power station introduces many complexities in its operation, they are as follows

- i) Need of additional equipment
- ii) increase in production cost

* Need of additional equipment:- The variable load on a power station needs to have additional equipment. For example let us consider a steam power station, in which coal, air & water are the raw materials, in order to produce variable power, the supply of these materials will be varied correspondingly,

* For an instance if the power demand on the plant increases, it must be followed by the supply of coal, air & water to the boiler to meet increased demand, so that additional equipment is installed.

* In model power plant, much equipment is placed to adjust the rate of the supply of raw material according to the variation in power demand.

* Increase in production cost :- The variable load on power plant increases the cost of production of electrical energy. An alternator operates at maximum efficiency near its rated capacity. If a single generator is used, it will have poor efficiency during light load on the power plant.

* In practice a no. of alternators of different capacity are installed so that, the alternator can be operated at full load capacity, use of alternators increase initial cost per kW of the plant capacity.

* cost analysis

The overall annual cost of electrical energy generated by a power station is expressed in two forms namely

- ① three part form ② two part form

* Three part form :- in this method the overall annual cost of electrical energy generated is divided into three parts i.e. fixed cost, semi-fixed cost, running cost.

$$\begin{aligned} \text{Total annual cost of energy} &= \text{Fixed cost} + \text{Semi-fixed cost} + \text{running cost} \\ &= \text{constant} + \text{proportional to max demand} \\ &\quad + \text{proportional to kWh generated} \\ &= Rs [a + b \text{ kW} + c \text{ kWh}] \end{aligned}$$

Where a = annual fixed cost, it is independent of maximum demand & energy output

b = constant which is multiplied by maximum kW

demand on the station, gives the annual semi-fixed cost.

c = a constant which is multiplied by kWh output per annum gives annual running cost

b) Two part tariff :- it is convenient to give annual cost of energy in two part form, Here annual cost is divided into fixed sum per kW of maximum demand + running charges percent of energy.

$$\therefore \text{Total annual cost of energy} = RS(A \text{ kW} + B \text{ kWh})$$

Where A = a constant which is multiplied by max kW demand

B = a constant which is multiplied by kWh generated annually gives annual running cost.

* Method of determining depreciation.

- i) Straight line method
- ii) Diminishing value method.
- iii) Sinking fund method.

* Straight line method :- In this method, a constant depreciation charge is made every year on the basis of total depreciation & useful life of the property.

* usually annual depreciation charge will be equal to the total depreciation divided by the useful life of the property,

They if the initial cost of equipment is RS 1,00,000 & its scrap value is RS 10,000 after useful life of 20 years then,

$$\begin{aligned} \text{Annual depreciation charge} &= \frac{\text{Total depreciation}}{\text{useful life}} \\ &= \frac{1,00,000 - 10,000}{20} = 4,500. \end{aligned}$$

In general, the annual depreciation charge on the straight line can be expressed as
$$= \frac{P - S}{n}$$

where P = initial cost of equipment

n = useful life of equipment in years.

S = scrap or salvage value after the useful life of the plant.

The straight line method is extremely simple and it is easy to apply as the annual depreciation charge can be calculated from total depreciation of useful life of equipment.

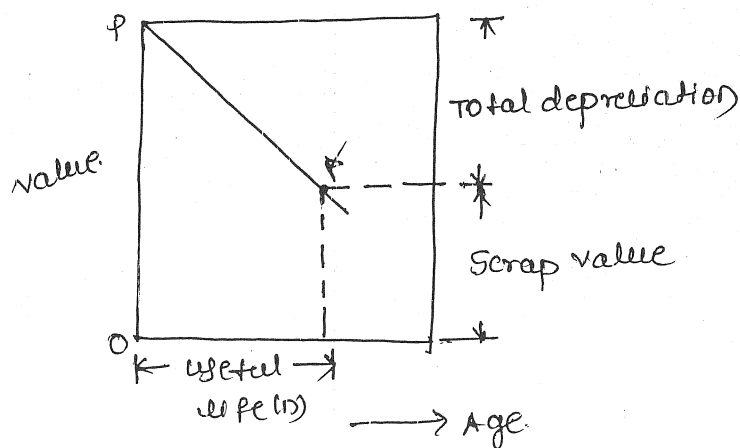

fig-a)

The above fig. shows the graphical representation of the straight line method, it is clear that the initial cost of the equipment i.e. P decreases, with increase in straight line represents constant value of depreciation.

* Diminishing value method:-

In this method, depreciation value is made every year at a fixed rate based on diminished value of the equipment. For example suppose the initial

cost the equipment is RS 10,000 & its Scrap value after its useful life is zero. If annual rate of depreciation 10%, then depreciation for 1st year = $0.1 \times 10,000$ RS = 1000. \therefore the value of the equipment is decreased by 1000 and becomes 9000. and for the next year the value of the equipment becomes 8100.

* For the 3rd year the value of the equipment becomes.

$$8100 - 810 = 7290.$$

* Mathematical treatment

Let P = capital cost of equipment

n = useful life of the equipment in years

S = Scrap value after the useful life

Suppose the annual unit of depreciation is x , then it is desired to calculate the value of x in terms of P, n &

S .

\therefore value of the equipment after one year.

$$= P - Px = P(1-x)$$

value of the equipment for next year.

= diminished value - annual depreciation

$$= [P - Px] - [(P - Px)x]$$

$$= P - Px - Px + Px^2$$

$$= P(x^2 + 2x + 1)$$

$$= P(1-x)^2$$

\therefore value of the equipment after n years

$$= P(1-x)^n //$$

But the value of the equipment after n years is equal to the scrap value S .

$$\therefore S = P(1-x)^n$$

$$(1-x)^n = S/P$$

$$1-x = (S/P)^{1/n}$$

$$x = 1 - (S/P)^{1/n} \quad \text{--- (1)}$$

From the above equation annual depreciation can be easily found.

$$\begin{aligned} \therefore \text{depreciation for 1st year} &= xp \\ &= P \left[1 - (S/P)^{1/n} \right] \end{aligned}$$

This method is more rational than the straight line method. The below fig shows graphical representation of the method. As shown the initial value P of the equipment reduces through depreciation to the scrap value S over the path PA .

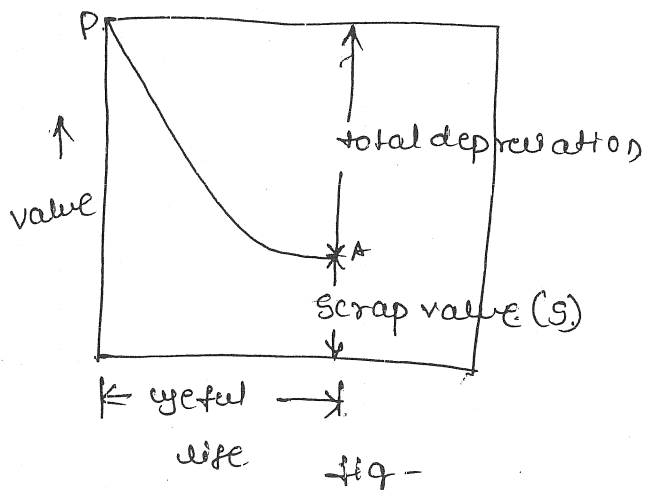

* Sinking fund method :- In this method, a fixed depreciation charge is made every year and interest compounded on it annually.

* The constant depreciation charge is such that the total amount of annual instalments + the total amount of interest accumulations equal to the cost of replacement of equipment after its useful life

Let p = Initial value of equipment

n = useful life of equipment in years

S = scrap value after useful life

r = annual rate of interest expressed as

decimal cost of replacement = $p - S$

* Suppose an amount of q is set as depreciation charge every year & interest compounded on it is

$p - S$ is available after n years

An amount of q at ^{annual} interest rate of r , will

become $q(1+r)^n$ at the end of n years

* Now the amount q deposited at the end of 1st year will earn compound interest for $n-1$ years become

$$q(1+r)^{n-1} \text{ i.e.}$$

* amount of q deposited at the end of 2nd year

$$= q(1+r)^{n-2}$$

at the 3rd year = $q(1+r)^{n-3}$

* Similarly at the end of $n-1$ year = $q(1+r)^{n-(n-1)}$

$$= q(1+r)$$

$$\therefore \text{total fund after } n \text{ years} = q(1+r)^{n-1} + q(1+r)^{n-2} + \dots + q(1+r)$$

$$= q \left[(1+r)^{n-1} + (1+r)^{n-2} + \dots + (1+r) \right]$$

the sum is given by $\text{total fund} = q \frac{(1+r)^n - 1}{r}$
 the total fund must be equal to the total cost of replacement of the equipment.

$$p - s = q \frac{(1+r)^n - 1}{r}$$

$$\text{or sinking fund } q = (p - s) \left[\frac{r}{(1+r)^n - 1} \right] \quad \text{it gives}$$

uniform annual depreciation charge.

* Different terms considered for power plants & their significance

1) connected load :- The sum of the continuous ratings of all the electrical equipments connected to the supply system is known as connected load.

for example if a consumer has connections of five 100-watt lamps and a power point of 500 watts, then connected load of the consumer is $5 \times 100 + 500 = 1000$ watts. The sum of the connected load of all the consumers is the connected load to the power station.

* Maximum demand :- It is the greatest demand of load on the power station during given period.

The load on the power station varies from time to time. Maximum demand on the power station is generally less than the connected load because all the consumers do not switch their connected load at a time.

* Average load or Average demand :- The average load or demand on the power station is the average of loads occurring on the power station at various events (day or month or year).

Depending upon the duration of time period such as a day, month or year, we get daily or monthly or annual average load.

$$\text{Daily average load} = \frac{\text{No of units (kwh) generated in a day}}{24 \text{ hours}}$$

$$\text{Monthly avg load} = \frac{\text{No of units (kwh) generated in a month}}{\text{month}}$$

$$\text{Yearly avg load} = \frac{\text{No of units (kwh) generated in year}}{\text{No of hours in month (24 \times 30)}} \\ 8760 \text{ hours (24 \times 365)}$$

* Load factor :- The ratio of average load to the maximum demand during a given period is known as load factor.

$$\text{Load factor} = \frac{\text{average load}}{\text{Maximum demand}}$$

If plant operation is for T hour

$$\text{Load factor} = \frac{\text{average load} \times T}{\text{Maximum demand} \times T}$$

$$= \frac{\text{units generated in T hours}}{\text{max demand} \times T \text{ hours}}$$

usually the load factor may be daily, monthly or annual load factor if the time period is considered as a day or month or year.

Load factor is less than 1 because average load is always less than the maximum demand.

* Diversity factor :- It is defined as the ratio of the sum of individual maximum demand of individual category to the maximum demand of the power station.

$$\text{Diversity factor} = \frac{\text{Sum of individual Max. demand}}{\text{Maximum demand of the station.}}$$

The value of diversity factor is always more than 1.

* Demand factor (peak load factor) :- The ratio of actual maximum demand on the system to the total rated load connected to the system is known as demand factor. It is always less than unity.

$$\text{Demand factor} = \frac{\text{Maximum demand}}{\text{connected load.}}$$

* Plant capacity factor :- The plant capacity factor is similar to the load factor. The load factor refers to the total load on the station and total capacity of the station, whereas plant factor relates only to one particular plant, it is the ratio of average load to the rated capacity of the power plant.

$$\text{Plant factor} = \frac{\text{Average load or avg demand}}{\text{Rated capacity of power plant}}$$

Where as plant capacity factor is defined as the actual energy generated divided by the max-

possible energy that could have been produced during a given period.

$$\begin{aligned} \text{plant capacity factor} &= \frac{\text{Actual energy produced}}{\text{Max. energy that could have been produced.}} \\ &= \frac{\text{Average demand} \times T}{\text{plant capacity} \times T.} \end{aligned}$$

$$\begin{aligned} \text{annual plant capacity factor} &= \frac{\text{Annual kWh output}}{\text{plant capacity} \times 8760} \end{aligned}$$

* plant utilization factor :- it is defined by the ratio of maximum demand on power station to the rated capacity of the power plant. it is always less than 1

$$\text{utilization factor} = \frac{\text{Max demand on power station}}{\text{Rated capacity of the power plant.}}$$

* Interconnected grid system

The connection of several generating stations in parallel is known as interconnected grid system.

The various problems facing by the power engineers are considerably reduced by interconnecting different power stations in parallel. Even though the interconnection of station includes extra cost, but it is gaining much favour these days.

* Some of the advantages of interconnected s/m are as follows.

1) exchange of peak load :- An important advantage of interconnected system is that, the peak load of the power station can be exchanged.

* If the load curve of a power station shows a peak demand which is more than the rated capacity of the plant, then excess load can be shared by other stations interconnected with it.

2) Use of older plants :- The interconnected s/m make it is possible to use the older & less efficient plants to carry peak loads for short durations & interconnected s/m give a direct kick to the use of obsolete plants.

3) Ensures economical operation :- The interconnected s/m make the operation of power stations quite economical, because the sharing of load among the power stations is arranged in such a way that, more efficient stations work continuously throughout the year at a high load factor. & less efficient plants work for p only for peak load condition.

4) increases the diversity factor :- The load curves of different interconnected stations, are generally different due to which the result is that the maximum demand on the s/m is reduced as compared to the sum of individual maximum demands on power stations. In other words the diversity factor of the s/m is improved, thereby increasing the effective capacity of the system.

* Reduce plant reserve capacity:- Every power station is required to have a standby unit for emergency. When several power stations are connected in parallel, the reserve capacity of the SIm is much reduced, which increases the efficiency of the SIm.

* Increased reliability of supply:- The interconnected SIm increases the reliability of the supply. If a major breakdown occurs on ^{one} station then continuity of supply can be maintained by other healthy station.

* choice of size and number of generating plants.

The load on a power system is never constant it varies at the different times of the day. The peak load occurs only a short duration, a single generating unit is not economical to meet the varying load, because a single generating unit will have very poor efficiency during the light load on the power station.

* Therefore in actual practice, a no of generating units of different sizes are installed in a power station

* The selection of the number and size of the units are decided based on the annual load curve of the station.

* The number and size of the units are selected in such a way that they correctly fit the station load curve.

* The selection criteria for number & size of generating units have following points →

① The no and size of the generating units should

be selected such that they approximately fit the annual load curve of the station.

- 2) The units should be preferably of different capacities to meet the load requirements
- 3) The capacity of the plant should be made 15% to 20% more than the maximum demand to meet the future load requirements
- 4) There should be a spare generating unit so that the repair & overhauling can be carried out.
- 5) The tendency to select a large no of units of smaller capacity is, to fit the load curve very accurately.

* Tariffs

The rate at which electrical energy is supplied to a consumer is known as tariff. Tariff include the total cost of producing and supplying electrical energy + profit. tariff can't be same for all types of consumers.

* objectives of tariff

- 1) To recover the cost of ~~very~~ capital investment in ~~gener~~ in generating, transmitting and distributing equipment.
- 2) To recover the cost of operation, supply & maintenance of the equipment.
- 3) To recover the cost of metering equipment, billing, collection costs.
- 4) To have a suitable profit on the capital investment.
- 5) To recover the cost of production of electrical energy at the power station.

* Types of tariff

- 1) Simple tariff
- 2) Flat rate tariff
- 3) Block rate tariff
- 4) Two part tariff
- 5) Maximum demand tariff.
- 6) power factor tariff
 - i) kVA maximum demand tariff.
 - ii) Sliding scale tariff.
 - iii) kWh and kVAR tariff.
- 7) Three part tariff.

* Simple tariff:- it is the simplest type of tariff, in which cost of energy consumption is considered based on the no of units consumed. it is also known as uniform rate tariff.

In this type of tariff, price charged per unit is constant i.e it will not vary with increase or decrease in number of units consumed. The total consumption of electrical energy at the consumer side is recorded by means of energymeter.

* The advantage of single type of tariff is, it is more fair to different types of consumers & it is quite simple institutions.

* disadvantage:-

- ① There is no discrimination b/w different types of consumers, every consumer has to pay equal fixed charges.

ii) the cost of per unit delivered is high.

iii) It does not encourage the use of electricity.

* Flat rate tariff :- When different type of consumer are charged at different per unit rates, it is called a flat rate tariff.

In this type of tariff, the consumers are grouped into different classes and each class of consumer is charged at a different uniform rate.

The advantage of such type of tariff is that it is more fair to the different types of consumer & it is quite simple in calculation.

* disadvantage :-

- ① Separate meters are required for night load, power load etc.
- ② as the tariff varies according to the way of supply is used & it is very expensive & complicated.

* Block rate tariff :- In this type of tariff a given block of energy is charged at a specified rate and the succeeding blocks of energy are charged at progressively reduced rates known as block rate tariff.

In block rate tariff, energy consumption is divided into blocks & the price per unit is fixed in each block. The price per unit in 1st block is highest and it is reduced for succeeding blocks of energy.

For an example initially 25 units may be charged at the rate of Rs. 4.00 per unit, the next 40 units may be charged at the rate of Rs 3.50 per unit. The consumption exceeding 65 units may be charged at the rate of 3.00/unit.

* The advantage of such type of tariff is that the consumer will get an incentive for consuming more electrical energy, which increase the load factor and reduce the generation cost.

* The drawback is, it lacks a measure of the consumer demand.

* Two part tariff :- When the rate of electrical energy is charged based on the maximum demand of the consumer and the no of units consumed, it is known as two part tariff.

In two part tariff, the total charge made by the consumer is split in two components i.e. fixed charge and running charge. The fixed charge is dependent on the maximum demand of the consumer whereas running charges are depend upon the no of units consumed by the consumer.

This type of tariff is generally applicable to industrial consumers.

* advantage

- 1) it is easily understood by consumer.
- 2) It removes fixed charges which depend upon the max. demand of the consumer but independent of the no of units consumed.

* disadvantage

- 1) The consumer has to pay the fixed charge irrespective of the fact that, whether he has consumed

or not consumed the electrical energy.
2) There is always error in assessing the Max demand of the consumer.

5) Maximum demand tariff :- it is similar to that of the two part tariff except that in this case Max demand is actually measured by max. demand indicator instead of assessing it on the basis of reliable value.

In this method the drawback of two part tariff method is removed. It is applicable to all bulk supplies and large industrial consumer. At the same time this type of tariff is not suitable for small consumer as separate max demand meter is required.

* power factor tariff :- The tariff in which power factor of the consumer load is taken into consideration is known as power factor tariff.

The efficiency of plant and equipment depends upon the power factor, \therefore in order ~~to increase~~ to increase the utility of the plant & the equipment to the maximum, the power plant must be operated at the most economical power factor.

Therefore sometime the consumer has to ^{pay} penalty for poor power factor. by applying the following types of power factor tariffs.

- a) kVA Maximum demand tariff
- b) kWh and kVAR tariff
- c) Average power factor tariff

* kVA Maximum demand tariff :- In this type tariff, the fixed charge is based on Maximum kVA demand instead of Maximum kW. kVA maximum demand tariff encourage the consumer to operate their machinery and other equipment at the improved power factor and hence the consumer has to pay more.

on the other hand the consumer tries to improve the pf of his load by installing the pf improvement device which will be more economical.

* kWh and kVARh tariff :- In this type of tariff, the consumer not only pay for the real energy consumed i.e kWh but also for the reactive energy kVARh. If the pf is low, the consumer has to pay more for kVARh, Hence he tries to improve the power factor by installing pf improvement device due to which reactive energy kVARh decrease.

* Pf penalty or bonus tariff :- In this type of tariff, a certain pf say 0.9 lagging is taken as reference pf. If the load pf is less than this, the consumer has to pay penalty.

on the other hand if the pf is more than 0.9 he will be rewarded with a bonus.

* Three part tariff :- When the total charge to be made from the consumer is split into three part i.e., fixed, semifixed and running charge, then it is known as three part tariff

$$\text{Total charge} = RS (a + b \times kW + c \times kWh)$$

where a = fixed charge made during each billing period. It includes interest and depreciation on the cost of secondary distribution & labour cost of collecting revenue.

b = charge/kW of maximum demand.

c = charge/kWh of energy consumed.

This type of tariff is generally applied to big consumers.

* power factor

The power factor of an ac circuit can be defined into three different ways.

i) power factor = $\cos \phi$

The power factor of an ac circuit is defined as the cosine of the angle b/w voltage and current.

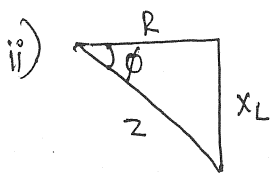

The impedance diagram for an inductive load is as shown above from which $\cos \phi = R/Z$

Therefore the power factor of an ac circuit is defined as the ratio of resistance to impedance of the circuit.

iii) The relation b/w real power, and apparent power in an ac circuit is as shown below.

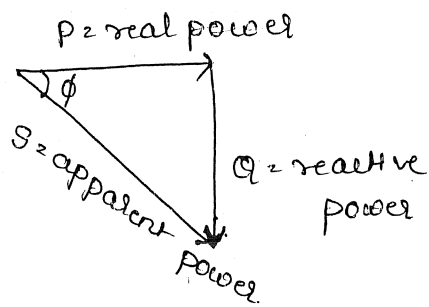

from the fig, $\cos\phi = \frac{\text{Real power}}{\text{Apparent power}} = \frac{\text{kW}}{\text{kVA}}$

\therefore the pf of an ac circuit is defined as the ratio of real power to apparent power.

* disadvantages of low power factor

The power factor plays an important role in ac circuits since power consumed depends on this factor.

$P = VL I_L \cos\phi$ for single phase supply.

$\Rightarrow I_L = P / VL \cos\phi$ — (1)

$P = \sqrt{3} VL I_L \cos\phi$ for 3- ϕ supply.

$I_L = P / \sqrt{3} VL \cos\phi$ — (2)

from the above ^{eqn} ~~fig~~ it is clear that, the load current is inversely proportional to the power factor. low pf cause high load current which introduces the following disadvantages

1) The kVA rating of alternators & transformers are proportional to the load current, If pf is low, the current drawn will be more. \therefore large generators and transformers are required to deliver the same load at low power factor.

* Module - 5 * disadvantage of LPF.

ii) ~~at increased eff~~ due to the increase in current because of low p.f., the voltage drop in line also increases & voltage across load decreases. The reduced voltage adversely affects the performance of the loads.

If it is an incandescent lamp, its illumination is drastically reduced.

* If it is a fluorescent tube, it won't light up. If it is an motor, its starting torque is adversely affected.

3) The current carrying capacity of the bus bar, conductors, and switchgear equipments depends on the cross-sectional area. due to low p.f. the current is increased and cross-sectional area of the bus bar, conductors and contact surface of the switch gear has to be increased, which causes additional expenditure.

4) as $\cos \phi$ is increased due to low p.f. the copper losses (I^2R) are increased & hence, efficiency is decreased.

* Causes of low power factor

The low p.f.s are caused mainly because of the type of load connected to the supply. Most of the industrial and domestic loads are inductive nature hence the $\cos \phi$ drawn by these loads lag applied voltage by certain angle which causes the reduction in p.f.

The various types of loads which are the causes of low power factor are \rightarrow .

1) Most of the ac motors are of induction type (1 ϕ & 3 ϕ) which are more widely used in industries & agriculture.

at light load, they operate at very low power factor of 0.3 to 0.4, at full load they operate at 0.8 pf, single phase induction motors also operate at low pf of 0.6.

* Transformers draw magnetizing current from the supply to produce flux in core, at normal load, which will not affect pf more, ^{But} at light load, the magnetizing c/s makes the total c/s to lag more w.r.t. to applied voltage hence pf decreases.

* due to their typical characteristics, the arc lamps used in cinema projector work at low pf.

* The arc furnace & induction furnace work at low pf.

* The current limiting reactors used to minimize fault currents, fluorescent lamps work at low pfs.

* Short transmission lines also work at low pfs.

Imp * Advantages of power factor improvement

The improvement of the power factor using pf improvement devices have the following advantages:

- 1) The kVA rating of the generator can be reduced for a given kW of power supplied to the load, this reduces the cost per kW of power generated.
- 2) The sizes of conductors, cables and switchgear are reduced, as the c/s drawn is reduced.
- 3) The copper losses are reduced and hence the efficiency of transmission of power is increased.
- 4) The regulation of the power sys is improved, as the voltage drop in line is decreased.

5) The fixed charges and running charges are reduced.

* Cost of Electrical energy.

The total cost of electrical energy generated can be divided into three parts

- i) Fixed cost
- ii) Semifixed cost
- iii) Running or operating cost.

* Fixed cost :- It is the cost which is independent of maximum demand and no of units generated.

The fixed cost is due to the annual cost of central organization, interest on capital cost of land & salaries of high officials.

* The annual expenditure on the central organization and salaries of high officials are fixed, it has to met whether the plant has high or low demand or it generates less or more units.

* The capital investment on the land is fixed hence the amount of interest is also fixed.

* Semi-fixed cost :- It is cost which depends upon maximum demand but independent of no of units generated.

* The semi-fixed cost is directly proportional to the maximum demand on power station & is on account of annual interest and depreciation on capital investment of building & equipment, taxes, salaries of management and clerical staff.

* The maximum demand on the power station determines its size and cost of installation.

* The taxes and clerical staff depend upon the size of the plant & on maximum demand.

iii) Running (Operational) cost :- Running cost depends upon the no of units generated.

* The running cost is on account of annual cost of fuel, lubricating oil, maintenance repair and salaries of operating staff. The running cost is directly proportional to the number of units generated by the station.

* It is clear that if the power station generates more units, it will have high running cost & vice versa.

* Interest and depreciation related to power plant.

1) Interest :- The cost of use of money is known as interest.

Generally the big projects of power plants need large amount of capital. The required amount is generally borrowed from banks and other financial organizations, for this the company has to pay the annual interest on that amount.

* Even if the company has spent, out of its reserve funds the interest must be allowed for, since this amount could have earned interest if deposited in a bank.

* Therefore while calculating the cost of production of electrical energy, the interest payable on the capital investment must be included.

* However the rate of interest depends upon market position & other factors & it may vary from 4% to 8% per annum.

ii) Depreciation :- The decrease in the value of power plant equipment & building due to constant use is known as depreciation.

* If the power plant equipment were to last forever, then interest on the capital investment would have been ~~made~~ the only charge to be made.

* Hence in practice, every power station has a useful life ranging from 50 to 60 years, once the station is get installed, gradually the equipments are subjected to wear & tear, hence the value of plant is get reduced. This reduction in the value of power plant every year is known as annual depreciation. due to depreciation the plant has to be replaced by the new after its useful life.

* Therefore suitable amount is set as depreciation equal to the cost of replacement, of power plant equipment.

Basically there are 3 different methods are used to calculate depreciation

- a) straight line method
- b) diminishing value method.
- c) sinking fund method.

* Methods of improving the power factor.

The various methods used for improvement of pf are as follows

- 1) By using static capacitors
- 2) By using synchronous condensers
- 3) By using phase advancers
- 4) By using phase compensated motors.

* By using static capacitors :-

a) Single phase circuit :- Consider an inductive load consisting of R and L connected to an ac supply of voltage E . as shown in below fig.

Let I_1 be the load c/n which lags the applied voltage E by an angle ϕ_1 , Let $\cos\phi_1$ be pf of the load circuit. Now the capacitor C is connected across the load to improve the pf of the circuit. The c/n I_C drawn by the capacitor leads the applied voltage by an angle 90° .

Let I_2 be the total c/n drawn from the supply, which is the vector sum of I_1 & I_C .

Now the c/n I_2 lags applied voltage E by an angle of ϕ_2 , ϕ_2 is less than ϕ_1 i.e pf is improved from $\cos\phi_1$ to $\cos\phi_2$, the circuit connections & vector diagram are as shown below.

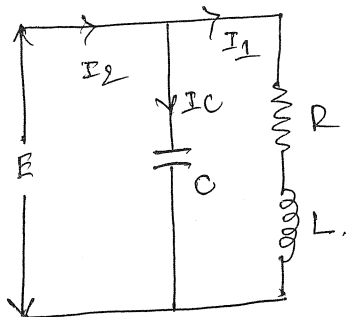

fig-a)

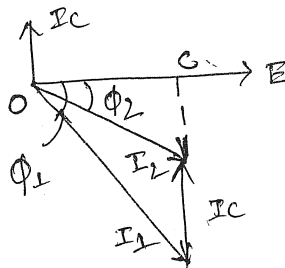

fig-b.

from the vector diagram, we find that

$$OC = I_1 \cos\phi_1 = I_2 \cos\phi_2$$

$$\text{or } I_2 = \frac{I_1 \cos\phi_1}{\cos\phi_2} \quad \text{--- (1)}$$

$$\text{also } EI_1 \cos\phi_1 = EI_2 \cos\phi_2$$

$$P_1 = P_2 = P. \quad \text{--- (2)}$$

from the equation (2) it is clear that the power taken from supply is not changed, when the pf is improved from $\cos\phi_1$ to $\cos\phi_2$ & the c/w drawn by the load also remains constant.

The power diagram is as shown below.

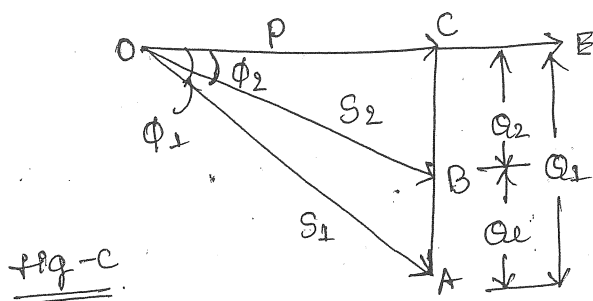

Let $P =$ active power taken from supply.

$Q_1 =$ reactive power taken by the load.

$Q_2 =$ reactive power taken by the supply after connecting the capacitor.

$Q_c =$ reactive power taken by the capacitor.

$$Q_c = Q_1 - Q_2 = P \tan\phi_1 - P \tan\phi_2$$

$$= P (\tan\phi_1 - \tan\phi_2)$$

$$P = EI_c = EI_1 \cos\phi_1 (\tan\phi_1 - \tan\phi_2)$$

$$I_c = I_1 \cos\phi_1 (\tan\phi_1 - \tan\phi_2) \quad \text{--- (3)}$$

$$= I_2 \cos\phi_2 (\tan\phi_1 - \tan\phi_2) \quad [\because P = EI_2 \cos\phi_2]$$

$$I_c = \frac{E}{X_c}$$

$$= E / (1/\omega C) = E\omega C \quad \text{or} \quad C = I_c / \omega E \quad \text{--- (4)}$$

the equation (4) gives the value of capacitance required

to improve the pf from $\cos\phi_1$ to $\cos\phi_2$.

* Three phase circuits

The power factor improvement problems in 3-phase circuits are solved on 1-phase basis, for the improvement of pf in three phase circuits, the capacitors required in each phase are either connected in star or in delta fashion as shown below.

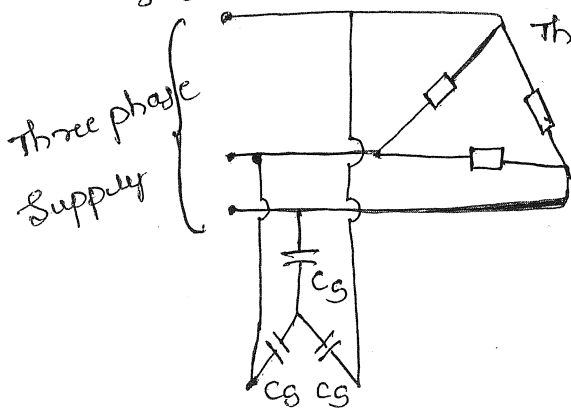

Fig-a

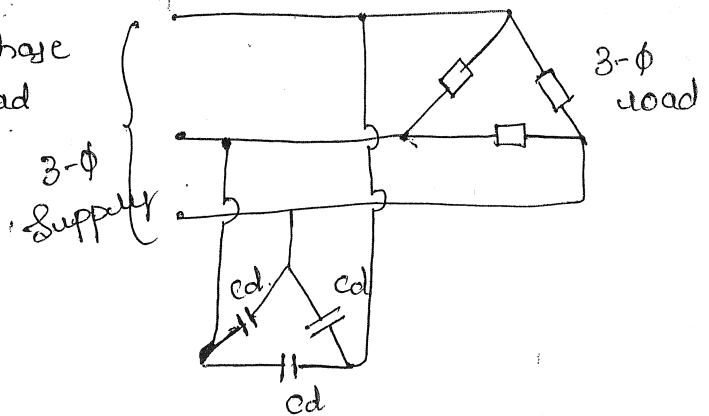

Fig-b

Let E_L = line voltage

E_p = phase voltage

C_s = capacitance per phase connected in star fashion

C_d = " " " " delta "

Q_c = VAR rating of each capacitor.

When circuit is star connected

$$C_s = \frac{I_c}{\omega E_{ph}} \quad \text{or} \quad E_{ph} C_s = \frac{I_c}{\omega}$$

$$C_s = \frac{Q_c}{\omega E_{ph}^2} = \frac{Q_c}{\omega \left(\frac{E_L}{\sqrt{3}}\right)^2} = \frac{3 Q_c}{\omega E_L^2} \quad \text{--- (1)}$$

When circuit is delta connected

$$C_d = \frac{Q_c}{\omega E_{ph}^2} = \frac{Q_c}{\omega E_L^2} \quad \text{--- (2)}$$

put the value of Q_c from eqn (1)

$$C_d = \frac{C_s \omega E_L^2}{3 \omega E_L^2}$$

$$\therefore C_s = 3 C_d$$

the eqn shows that

the capacitance required per phase in star connection is

equal to three times the capacitance per phase, when capacitors are connected in Δ or delta.

* Use of phase advancers.

The pf of an induction motor falls mainly due to the exciting c/s drawn from the ac mains, because the exciting c/s lags the voltage by an angle of 90° .

The pf can be improved with the help of set with an an exciter or phase advancer which supplies the exciting c/s to the rotor at slip frequency. Such exciter may be mounted on the same shaft of the main rotor or may be suitably driven by a prime mover.

The use of phase advancer for improving pf is not economical for motors below 150kW output. There are two types of phase advancers 1) Shunt type 2) Series type, depending upon whether, the exciting winding of the phase advancer is connected in series or in parallel with the rotor winding.

* Use of phase compensated motors.

The power factor of the induction motors whose output is less than 150kW is improved by using phase compensated motors such as torida, osnos & schrage motors. These motors are costlier & require more maintenance. \therefore Such motors are used for the pf improvement, when the IM's are running at rated load for most of the time and also, if the cost of the energy saved due to higher pf is more than the extra expenditure incurred to them.

* Economics of power factor improvement.

When the pf of a SIm is improved, there is a reduction in maximum kVA demand & there will be a saving in the maximum kVA demand charges. When the pf is improved, it involves capital investment on the pf improvement device.

* Therefore certain amount of money is annually used in the form of interest on the investment made on the pf improvement device & its depreciation has to be taken into account.

* The most economical pf is that value of pf at which the annual kVA maximum demand ^{saving} charges are more

These are two methods of finding the most economical

pf 1) When kW demand is constant

2) When kVA demand is constant

* Most economical pf when kW is constant.

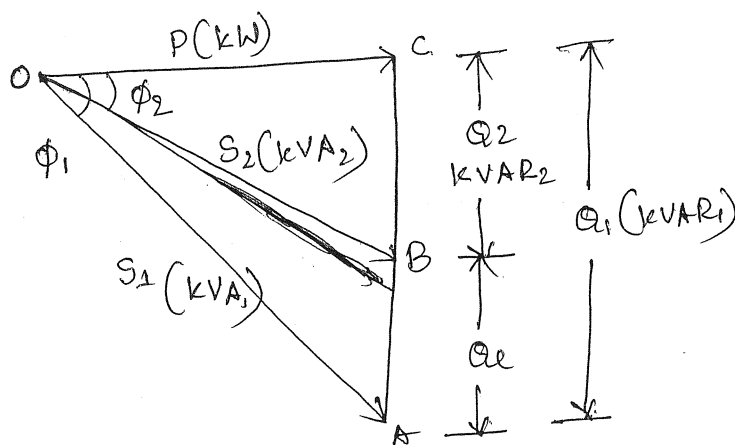

fig-a

Let $P =$ maximum kW demand which is kept constant at a pf of $\cos \phi_1$

$$S_1 = \text{total kVA at pf } \cos \phi_1 = kVA_1 = P \sec \phi_1$$

$$Q_1 = \text{total kVAR at pf } \cos \phi_1 = P \tan \phi_1$$

The pf is improved from $\cos\phi_1$ to $\cos\phi_2$ using pf improvement device, keeping P constant, as shown in the above vector diagram.

$$\text{Let } S_2 = \text{Total kVA at pf } \cos\phi_2 = kVA_2 = P \sec\phi_2.$$

$$Q_2 = \text{Total kVAR at pf } \cos\phi_2 = kVAR_2 = P \tan\phi_2.$$

$$\text{The saving in kVA maximum demand} = S_1 - S_2$$

$$= kVA_1 - kVA_2$$

$$= P \sec\phi_1 - P \sec\phi_2$$

$$= P(\sec\phi_1 - \sec\phi_2)$$

If $a =$ rate in rupees per kVA of maximum demand per annum, then annual savings in max demand charges in rupees

$$x_1 = aP(\sec\phi_1 - \sec\phi_2) \quad \text{--- (1)}$$

The leading kVAR supplied by the pf improvement device

$$Q_e = Q_1 - Q_2$$

$$= P \tan\phi_1 - P \tan\phi_2$$

$$= P(\tan\phi_1 - \tan\phi_2)$$

Let $b =$ is annual expenditure towards interest and depreciation on the capital investment of the pf improvement device, then annual extra expenditure because of investment on pf improvement device in rupees

$$x_2 = bP(\tan\phi_1 - \tan\phi_2) \quad \text{--- (2)}$$

Net annual saving in rupees is given by

$$X = x_1 - x_2 = aP(\sec\phi_1 - \sec\phi_2) - bP(\tan\phi_1 - \tan\phi_2)$$

The saving is maximum when $\frac{dX}{d\phi_2} = 0$

$$\therefore \frac{dX}{d\phi_2} = aP(0 - \tan\phi_2 \sec\phi_2) - bP(0 - \sec^2\phi_2) = 0.$$

$$\therefore a \tan\phi_2 \sec\phi_2 = b \sec^2\phi_2$$

$QC = CE = DE - DC = BA - DC$ & increase in active power

The reactive $= S \sin \phi_1 - S \sin \phi_2$

$$kVA_{re} = S (\sin \phi_1 - \sin \phi_2)$$

$P_2 - P_1$, Let $a =$ annual cost

$$\text{per kW } x_1 = a (P_2 - P_1)$$

$$= a (S \cos \phi_2 - S \cos \phi_1) \quad \text{--- (1)}$$

Let $b =$ annual cost per kVAR of the pf improvement device.

Then the annual cost of the pf improvement device is given by.

$$x_2 = b Q_{re} = b S (\sin \phi_1 - \sin \phi_2) \quad \text{--- (2)}$$

The saving in annual charge by the installation of pf improvement device is given by.

$$x = x_1 - x_2 = a S (\cos \phi_2 - \cos \phi_1) - b S (\sin \phi_1 - \sin \phi_2) \quad \text{--- (3)}$$

The saving will be maximum when $dx/d\phi_2 = 0$ i.e.

$$-a S \sin \phi_2 + b S \cos \phi_2 = 0.$$

$$a \sin \phi_2 = b \cos \phi_2 \quad \text{i.e. } \tan \phi_2 = b/a = \frac{\sin \phi_2}{\cos \phi_2}$$

$$\phi_2 = \tan^{-1} b/a \quad \text{i.e. } \cos \phi_2$$

$$\text{Most economical pf} = \cos \phi_2 = \cos \left[\tan^{-1} b/a \right]$$

